

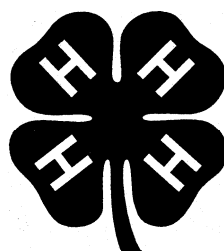

The Care of Dogs and Puppies

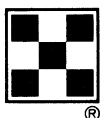

This educational material has been prepared for 4-H use by the National 4-H Dog Care & Training Development Committee, composed of representatives of the Cooperative Extension Service of the U.S. Department of Agriculture and State Land Grant Universities in cooperation with the National 4-H Council. Dr. Dennis A. Hartman, Professor of Dairy Science, Virginia Tech, served as principal author.



Special thanks are extended to Purina Dog Foods Group, Ralston Purina Company, for financial and technical assistance. This material is published by the National 4-H Council, 7100 Connecticut Avenue, Chevy Chase, Md. 20815



The author wishes to acknowledge the assistance of the following 4-H members and adults who posed their dogs so patiently, and to Mrs. Jane Tutton for her drawings and consultation: Douglas Hartman, Mark Hartman, Rudi Schwarz and Duane Bray.

Programs and educational materials of National 4-H Council; Extension Service, United States Department of Agriculture; and all Cooperative Extension Services of the State Land-Grant Universities are available to all persons regardless of race, color, sex, age, religion, national origin or handicap. All are equal opportunity employers.

THE CARE OF DOGS AND PUPPIES

Table of Contents

	Page
Breeds of Dogs	3
Parts of the Dog	6
Glossary of Terms	6
The Dog Owner's Responsibilities	7
Selecting the Right Dog	9
Preparing for Your Puppy	13
Feeding the Mature Dog	15
Breeding	20
Care of the Bitch and Puppies	21
Feeding of the Bitch and Puppies	23
Internal Parasites	25
Dog Diseases Which May Be Transmitted to Humans	26
External Parasites	27
Diseases Preventable by Vaccination	28
First Aid For Your Dog	29
Building a Suitable Dog House	30

Breeds of Dogs

The companionship between man and dog has been strong for many years with proof given in the earliest parts of the Bible, Matthew 15:27 " . . . but even the dogs feed on the crumbs which fall from the master's table." Egyptians undoubtedly loved their dogs as pictures of hunting scenes with dogs were found in the tomb of Amten, in Egypt, dating back to the fourth dynasty, or between 2900 B.C. and 2751 B.C. These dogs were of the sight-hound type.

Prehistoric man also played an important role in the development of the dog. How or when the dog was domesticated is not known. The following theory is offered.

Primitive hunters brought wolf puppies home and tamed them. A species of wolves was bred that was unable to compete with wolves in the wild and they thus haunted man's campfires and lived on what food was available. The wolf is pack-oriented and thus cooperated with man and recognized him as the pack leader. The early domesticated dogs, being animals of the chase by inheritance from the wolf, joined the ancient hunters in the excitement of the chase. The hunter recognized the value of these animals in obtaining food, and a partnership was gradually formed.

Through the evolution of man came many changes in the dog. Men selected for different traits and developed dogs for different purposes. Thus the many different breeds of dog can be traced back to prehistoric times.

Recall, for a moment, some of these differences. Some fight silently, some with great snarling, some slash and tear, while others grab and hang on. Some dogs test the wind for scent, while others run by sight and still others trail by scent on the ground. Certain breeds have a strong sense of protecting property and life, while others have a stronger commitment of gaining a friend.

The American Kennel Club is the largest of the dog recording organizations in the United States. At this time over 125 breeds are recognized. More breeds will likely be recognized in the future. These breeds have been placed in six groups according to their purpose. They are: sporting dogs, hounds, working dogs, terriers, toys and non-sporting. (The United Kennel Club is another registry for dogs which compete in UKC field trials, foxhound trials, night hunts and water races around the United States.)

Group 1: Sporting Dogs

The sporting breeds include the pointers, setters, retrievers and spaniels. The pointers and setters are hunters that cover the ground with great speed and freeze like a statue at the scent of game birds. The retrievers are expert swimmers and excel at retrieving game, either in the field or water. Briers do not grow too thick to keep the hard working spaniel from flushing its game.

- | | |
|-----------------------------------|------------------------------------|
| <i>Pointer</i> | <i>Gordon Setter</i> |
| <i>German Shorthaired Pointer</i> | <i>Irish Setter</i> |
| <i>German Wirehaired Pointer</i> | <i>American Water Spaniel</i> |
| <i>Chesapeake Bay Retriever</i> | <i>Brittany Spaniel</i> |
| <i>Curly-Coated Retriever</i> | <i>Clumber Spaniel</i> |
| <i>Flat-Coated Retriever</i> | <i>Cocker Spaniel</i> |
| <i>Golden Retriever</i> | <i>English Cocker Spaniel</i> |
| <i>Labrador Retriever</i> | <i>English Springer Spaniel</i> |
| <i>English Setter</i> | <i>Field Spaniel</i> |
| | <i>Irish Water Spaniel</i> |
| | <i>Sussex Spaniel</i> |
| | <i>Welsh Springer Spaniel</i> |
| | <i>Vizsla</i> |
| | <i>Weimaraner</i> |
| | <i>Wirehaired Pointing Griffon</i> |



Figure 1 -The American Cocker Spaniel

Group II: Hounds

The hound breeds include those with long legs developed for speed, endurance and keen vision known as coursing hounds. The tracking hounds include the rather small

Beagle to the large Bloodhound, both of which trail by scent with diligence and patience.

- | | |
|--------------------------------|-------------------------------|
| <i>Afghan Hound</i> | <i>Dachshund (longhaired)</i> |
| <i>Basenji</i> | <i>Dachshund (wirehaired)</i> |
| <i>Basset Hound</i> | <i>American Foxhound</i> |
| <i>Beagle (15")</i> | <i>English Foxhound</i> |
| <i>Beagle (13")</i> | <i>Greyhound</i> |
| <i>Black and Tan Coonhound</i> | <i>Harrier</i> |
| <i>Bloodhound</i> | <i>Ibizan Hound</i> |
| <i>Borzoi</i> | <i>Irish Wolfhound</i> |
| <i>Dachshund (miniature)</i> | <i>Norwegian Elkhound</i> |
| <i>Dachshund (standard)</i> | <i>Otter Hound</i> |
| <i>Dachshund (smooth)</i> | <i>Rhodesian Ridgeback</i> |
| | <i>Saluki</i> |
| | <i>Scottish Deerhound</i> |
| | <i>Whippet</i> |

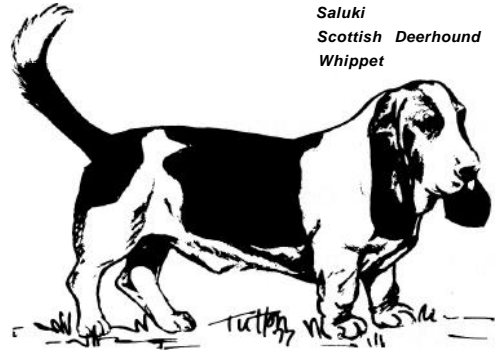

Figure 2-The Basset Hound

Group III: The Working Breeds

The working breeds were developed for serving man by drawing sleds and carts, driving cattle to market and protecting property. More recently they have been developed for guiding the blind and detecting bombs and narcotics.

- | | |
|------------------------------|--------------------------------|
| <i>Akita</i> | <i>German Shepherd dog</i> |
| <i>Alaskan Malamute</i> | <i>Giant Schnauzer</i> |
| <i>Australian Cattle Dog</i> | <i>Great Dane</i> |
| <i>Bearded Collie</i> | <i>Great Pyrenees</i> |
| <i>Belgian Malinois</i> | <i>Komondor</i> |
| <i>Belgian Sheepdog</i> | <i>Kuvasz</i> |
| <i>Belgian Tervuren</i> | <i>Mastiff</i> |
| <i>Bernese Mountain dog</i> | <i>Newfoundland</i> |
| <i>Bouvier des Flandres</i> | <i>Old English Sheepdog</i> |
| <i>Boxer</i> | <i>Puli</i> |
| <i>Briard</i> | <i>Rottweiler</i> |
| <i>Bullmastiff</i> | <i>St. Bernard (longhair)</i> |
| <i>Collie (rough)</i> | <i>St. Bernard (shorthair)</i> |
| <i>Collie (smooth)</i> | <i>Samoyed</i> |
| <i>Doberman Pinscher</i> | <i>Shetland Sheepdog</i> |
| | <i>Siberian Husky</i> |
| | <i>Schnauzer (standard)</i> |
| | <i>Cardigan Welsh Corgi</i> |
| | <i>Pembroke Welsh Corgi</i> |



Figure 3-The Rough Collie

Group IV: The Terrier Breeds

The terrier breeds are alert, bold dogs named after the Latin word, "terra", meaning earth, into which they follow their quarry. The terrier was developed to dig out the small animals chased underground by the tracking hounds. Many are small of size and can burrow through tunnels with ease. They are ferocious fighters once they corner their quarry.

<i>Airedale Terrier</i>	<i>Kerry Blue Terrier</i>
<i>American Staffordshire Terrier</i>	<i>Lakeland Terrier</i>
<i>Australian Terrier</i>	<i>Manchester Terrier (standard and toy)</i>
<i>Bedlington Terrier</i>	<i>Miniature Schnauzer</i>
<i>Border Terrier</i>	<i>Norfolk Terrier (drop ears)</i>
<i>Bull Terrier (white)</i>	<i>Norwich Terrier (prick ears)</i>
<i>Bull Terrier (colored)</i>	<i>Scottish Terrier</i>
<i>Cairn Terrier</i>	<i>Sealyham Terrier</i>
<i>Dandie Dinmount Terrier</i>	<i>Skye Terrier</i>
<i>Fox Terrier (wirehair)</i>	<i>Soft Coated Wheaten Terrier</i>
<i>Fox Terrier (smooth)</i>	<i>Staffordshire Bull Terrier</i>
<i>Irish Terrier</i>	<i>Welsh Terrier</i>
	<i>West Highland White Terrier</i>



Figure 4- The Fox Terrier (wire)

Group V: The Toy Breeds

The toy breeds are the smallest, ranging in size from 4-16 pounds. They were developed for the purpose of pleasure and companionship to their master or mistress. Many of the breeds were prized by the royalty of ancient times. Although they are small in size, they are plucky and long-lived.

<i>Affenpinscher</i>	<i>Maltese</i>
<i>Brussels Griffon</i>	<i>Miniature Pinscher</i>
<i>Chihuahua (smooth)</i>	<i>Papillon</i>
<i>Chihuahua (longhair)</i>	<i>Pekingese</i>
<i>English Toy Spaniel (Blenheim)</i>	<i>Pomeranian</i>
<i>English Toy Spaniel (Prince Charles)</i>	<i>Poodle (toy)</i>
<i>English Toy Spaniel (King Charles)</i>	<i>Pug</i>
<i>English Toy Spaniel (Ruby)</i>	<i>Shih Tzu</i>
<i>Italian Greyhound</i>	<i>Silky Terrier</i>
<i>Japanese Chin</i>	<i>Yorkshire Terrier</i>



Figure 5- The Yorkshire Terrier

Group VI: The Non-Sporting Breeds

The non-sporting breeds vary a great deal in their historical and physical characteristics. They also vary greatly in disposition and size. Although they were developed to perform certain purposes, today they serve chiefly as pets.

<i>Bichon Frise</i>	<i>Keeshond</i>
<i>Boston Terrier</i>	<i>Lhasa Apso</i>
<i>Bulldog</i>	<i>Poodle (standard)</i>
<i>Chow Chow</i>	<i>Poodle (miniature)</i>
<i>Dalmatian</i>	<i>Schipperke</i>
<i>French Bulldog</i>	<i>Tibetan Terrier</i>



Figure 6- The Dalmatian

Miscellaneous Breeds

Some miscellaneous breeds are granted ILP (Indefinite Listing Privileges) and registered by the American Kennel Club but not included in regular groups (although probable acceptance is the rule). They may compete in shows and obedience trials but are not eligible for points toward an AKC championship and are not eligible to compete in Variety Groups.

<i>Australian Kelpie</i>	<i>Pharaoh Hound</i>
<i>Border Collie</i>	<i>Portuguese Water Dog</i>
<i>Cavalier King Charles Spaniel</i>	<i>Spinoni Italiani</i>
<i>Miniature Bull Terrier</i>	<i>Tibetan Spaniel</i>

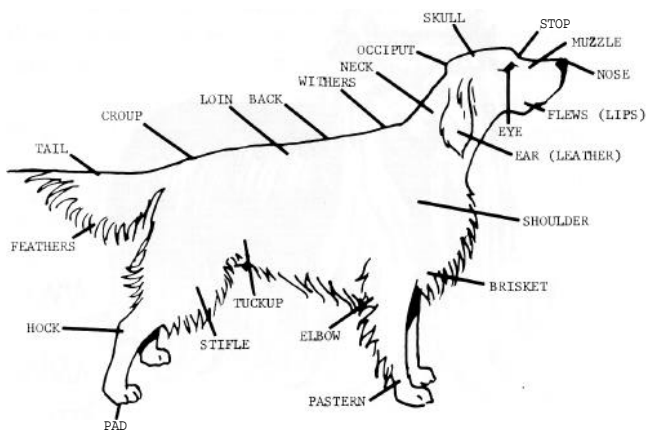

Figure 7- External Parts of the Dog

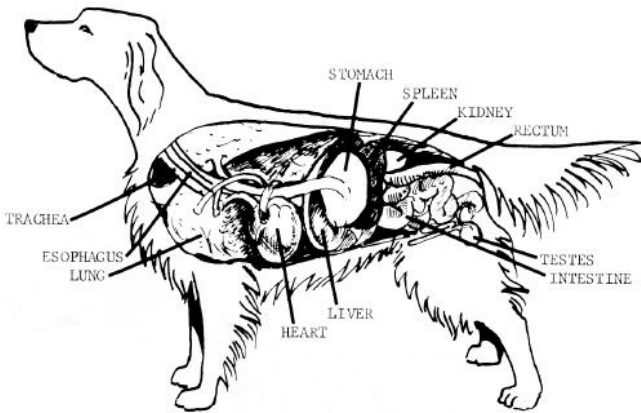

Figure 8- Some Internal Organs of a Dog

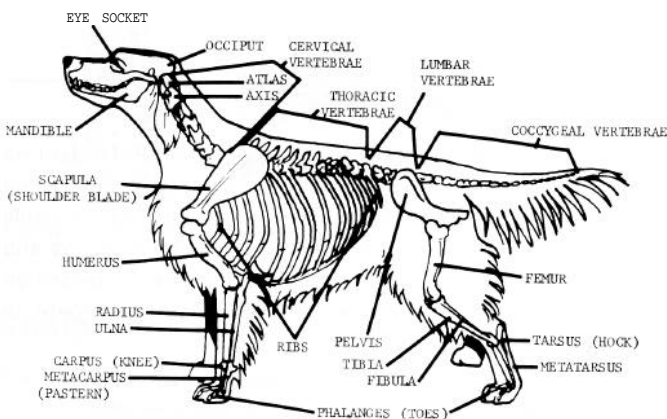

Figure 9- Skeletal Drawing of a Dog

GLOSSARY OF TERMS

Angulation. Angle made by bones at a joint as "shoulder angulation," or "hock and stifle angulation."

Apple Head. Rounded or domed skull.

Bat Ear. Carried erect, rounded tip.

Beard. Tuft of hair under the jaw or chin.

Belton. Two colors on one hair, as Orange Belton or Blue Belton in English Setters.

Blaze. Streak of color between the eyes.

Brindle. Streakings of color on a darker ground color.

Brisket. The chest or rib cage between and just behind the front legs.

Canine Teeth. The four sharp-pointed cutting teeth, sometimes called "tusks." Upper canines are called the "eyeteeth."

Chops. Lower cheeks

Clip. The pattern or style of clip placed on a dog, such as a Poodle.

Close-Coupled. Dog with a short loin and back.

Conformation. The structure and form of a dog as defined by its standard.

Cow-Hocked. Said of a dog whose rear pasterns and paws point outward with the hock joints close to each other.

Crop. Refers to the surgical trimming of a dog's ears

Croup. The area of the back from hip bones to the point where the tail joins the body.

Cur. A mongrel dog of no breed identity.

Dam. The mother of puppies. The male is the "sire."

Dewclaws. Extra toe and nail set above the normal toes on the inner aspect of the foot. Dewclaws have no value to the dog.

Dewlap. Loose fold of skin under the chin of some dogs.

Dish-faced. When the top jaw line is concave-the opposite of Roman-nosed.

Dock. To surgically shorten or remove a dog's tail

Down in Pastern. Said of a dog whose pastern is weak, making a pronounced angle between the paw and front knee.

Feather. Fringe of hair on legs and tail.

Fiddle Front. Bowed front legs, with elbows out from body, knees close together, and toes pointing out.

Flews. Loose-hanging lips, as in Bulldogs.

Front. Said of the chest and legs of the dog when viewed from the front.

Gait. Method of walking. Used as command, as "gait your dog."

Grizzle. Gray, or pepper-and-salt colors.

Haw. Condition when heavy cheeks pull down the lower eyelid to expose the red membrane.

Height. The perpendicular measurement of the dog from the ground to the highest point of the shoulders or withers.

Hock. Joint formed by second thigh and back pastern

In-breeding. Breeding of closely related animals, such as mother to son, brother to sister.

Incisors. Front teeth of each jaw between the canines.

Knee. Foreleg joint between elbow and foot. Hind-leg joint between tibia and femur.

Leather. The ear flap of hounds and spaniels.

Litter. A group of puppies born to a bitch

Loins. The sides between the ribs and hipbones.

Mask. Dark color on the muzzle, as in Boxers, Great Danes.

Merle. G-ray base color with darker center, as Blue Merle Collies.

Muzzle. The jaws, lips, and nose.

Occiput. Bump at the top rear of the skull in most breeds.

Out at Elbows. Elbows turned out from body.

Pad. Horny cover of the paw cushion.

Pastern. Part of foreleg between knee and foot, or between the hock joint and paw of the hind leg.

Plume. Feathering of the tail. Said of Pekingese, Collies

Porn-porn. Ball of hair left on end of the tail of Poodles.

Prick Ear. Ear carried erect.

Puppy. By usage, any dog under one year old.

Ring Tail. One that curls into a ring at the end

Rose Ear. Ear which folds back to expose part of inner ear.

Sable. Black or very dark brown. Often a lighter shade at base with black tips.

Screw Tail. Kinky, twisted tail.

Shelly. A flat, narrow body and insufficient depth of chest.

Sickle Tail. Tail curved up into sickle fashion.

Smooth Coat. Short, flat coat.

Snipy. Narrow, short muzzle insufficient to balance skull.

Spay. Remove the ovaries and uterus surgically

Splay Foot. A flat foot with toes spread, little cushion, and often with nails growing crooked.

Squirrel Tail. Curving forward over the back.

Stand-Off Coat. The outer coat stands straight out from the body.

Stern. The tail.

Stifle. The joint formed by the upper and lower thighs.

Stop. The area between the eyes and between the skull and muzzle.

Straight Shoulders. Poor angulation of shoulder bones.

Sway-Back. A concave top line between withers and hips.

Tri-color. Dogs of three colors, usually black, tan, and white.

Tuck-up. Abdomen drawn up tight to loins.

Tulip Ears. Carried erect with tips falling forward

Undershot. Under jaw longer than upper, projecting lower teeth beyond upper. The opposite of overshot.

Walleye. Blue eye as in Blue Merle Collies, Harlequin Danes, Dalmatians. Sometimes called china eye.

Withers. Top of shoulder blades at junction of neck.



Figure 10- A well designed and constructed house is necessary for a dog that lives outside.

The Dog Owner's Responsibilities

Any person who owns a dog should realize the commitment he or she has taken to provide proper feeding and care for a living animal. This responsibility means providing both time and money to support the luxury of owning a dog. This is a large responsibility.

Besides financial costs, there is the needed time for keeping your dog clean, picking up the droppings from the kennel or lawn, feeding and watering and training the dog to become a well-mannered pet. It takes additional time to house-train a puppy and keep out of reach the many things that a puppy may destroy by chewing. The initial cost of the puppy will be the smallest part of the **total** cost of having a dog.

This emphasizes the importance of careful selection of the puppy. The puppy that grows into a dog that may be inappropriate for your family requires the same amount of training and care, and costs as much to maintain, as a dog that you are really proud to own and care for.

The responsibility of owning a dog will continue throughout

the dog's life, which may exceed 10 years. Caring for a dog means constant **daily** care. It is not something that can be turned off and on as a machine. This point is made strongly because of the gross neglect by many dog owners.

Every dog owner has certain responsibilities to his or her neighbors. The following remarks apply to those who live in a home in a town or city and have a lawn that measures 75' x 75' or more. People who live in apartments and do not own a lawn have additional responsibilities and problems to meet.



Figure 1 I-Most breeds will sound an alarm when a stranger arrives and serve their duty well as a watch dog.

- Do not allow your dog to bark unnecessarily. If your dog is kenneled or tied outside, it should bark when someone comes near, but it should stop barking after you have acknowledged the visitor and have commented to the dog that all is well.

- A dog that lives indoors should be trained to react in a similar way.

- Do not allow your dog to bark unnecessarily when it hears another dog bark or for no obvious reason.

- Do not allow your dog to run free and be on your neighbor's lawn. Your neighbors may not appreciate your dog on their property for many reasons, and especially that of providing a bathroom area. A dog that is allowed to run free is likely to be injured in a traffic accident and also may be a party to causing an accident. If your dog is kept outside, it should be tied or kenneled at all times, except when under your control. You can, however, train your dog to stay on your property as discussed in the project manual, "Training your Dog for Family Living."

- Your dog should never be allowed to threaten anyone beyond barking. A dog that bites can inflict severe damage. If your dog develops a biting problem and becomes vicious and you are not successful in corrective training, you should seek professional advice and assistance. It will be very difficult to always protect visitors and your neighbors from your dog. Neighbors, friends and strangers should not be expected to take the chance of being bitten when they visit your home. Neither should you want to risk possible lawsuits.

- Under no circumstances should your dog be allowed to chase bicycles or cars. People have been killed in accidents caused by cars swerving or braking to avoid hitting a dog.

- A dog that lives outside should have a suitable dog house. You should also make sure your dog receives adequate exercise.

- Everyone does not love dogs. Some people are allergic to dogs or have a fear of them, based on a bad experience. When visitors arrive they should not have to put up with a dog that jumps up on them. Neither should they be placed in the embarrassing position of being asked to sit in a chair that the dog has sat in and which is covered with dog hair.

- When you visit friends you may sometimes wish to take your dog with you. This is fine if they do not mind. You should be realistic, however, and know that at most homes your dog will not be welcome. Your friends may enjoy your dog in your home but not in theirs.

As the human population increases, there will be greater pressure for living space. An anti-pet group may be made up of people who are sometimes referred to as "cranks", but it will also consist of people who are tired of their neighbor's undisciplined dogs.

It is not likely that in the immediate future pet owners will be deprived of the right to own a dog. As cities become larger and ecology problems become greater, certain restrictions may be made. Let us all be more aware of those who live around us. Each of us should make sure that other dog owners understand and carry out their responsibilities.

Pet owners also have the responsibility of controlling reproduction of their pet. Unless you have definite plans for using your dog for reproductive purposes or for showing at AKC breed shows, you should have the dog castrated or spayed. Even though your dog may be castrated or spayed, it is possible to compete in AKC obedience trials.

You may receive complete training for the above responsibilities from the 4-H dog manual, "Training Your Dog for Family Living."

Selecting the Right Dog

When you see that pup with the wagging tail, don't lose your sense of judgment. Remember that in about 12 months he will be a full grown dog, and for future happiness you should select a pup that will suit you and fit into your environment and life style when he is a grown dog.

Your dog will hold an important position in your household. A good dog will earn the love, kindness, and respect of the entire family. Dogs often live to the age of 10 years or more. Therefore, the decision of selecting a dog is lasting.

There are over 125 different breeds recognized by the American Kennel Club. You may be happy with either a purebred or a mixed breed. After some thought, you may decide that you would be happier with a dog of one breed or mix than another. Some of the points of consideration follow and each will be covered separately.

Mixed Breed or Purebred

Your first consideration should be whether to select a purebred or a mixed breed. If you select a purebred, you will be permitted to enter breed shows, obedience trials, field trials, use a male for stud service or raise and sell a litter of purebred puppies if you choose to do so. All of these opportunities may sound confusing now. Don't decide on these points until you understand them completely. Many people own purebred dogs and enjoy these events immensely as a hobby.

The greatest problem with selecting a mixed breed is not knowing what it will be as a mature dog. Puppies are cuddly and soft and completely irresistible. It may be impossible to think that your choice might eventually become a tall, shaggy dog with long drooping ears. Even if the puppy's mother is available for observation, you cannot be sure of mature appearance because the sire will represent one half of the genetic makeup and therefore greatly affect the dog's appearance and personality.

Study the Pedigree

A four generation pedigree shows the average genetic contributions made by the ancestors. When selecting a puppy you should give more consideration to the sire and dam than to the grandsire and granddam. An outstanding animal far back in the pedigree cannot significantly influence the animal's type or performance. Sometimes the person selling will make a great issue about the merits of the grandsire or granddam. These remarks should be taken lightly.

The breeds recognized by the AKC vary in size, conformation, personality, and the use for which they were bred. When selecting a purebred puppy you may have assurance that at maturity his coat, size, color and disposition should be close to the standard of the breed.

For a purebred puppy, it is usually better to go to a respectable dog breeder.

There is no truth to statements that purebred dogs are smarter than mixed breeds or that mixed breeds are healthier than purebreds. A dog's behavior depends largely upon his training and environment. The dog's health will depend upon the care you provide.

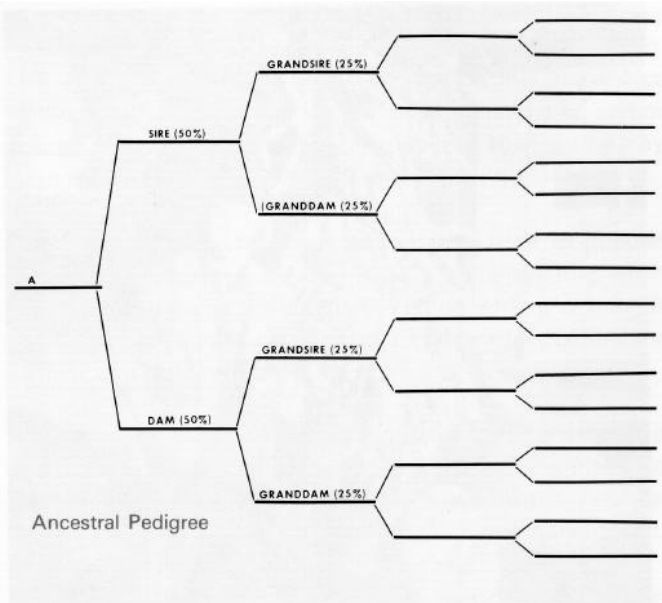

Dogs have been bred for many purposes. It is unfair to ask a dog to perform a task for which he was not bred. A Collie, for example, is not equipped with the nose-brain to hunt pheasants, and a Setter is not equipped with the herding instinct for driving livestock. Some breeds make better pets for children than others.

It costs no more to feed and care for a purebred than a mixed breed, and either may make a happy and healthy pet. However, if you should develop an interest in competing at

shows, obedience trials, field trials or breeding and raising a litter of puppies, you may do so if you own a purebred.

Show Type, Field Type or Just a Good Representative of the Breed

If you intend to compete in breed shows, you should first become well acquainted with the standards on which the breed is judged. Dogs in a show are judged on their conformation. Standards for breeds vary. The standards are printed in *The Complete Dog Book* by the American Kennel Club. Study these standards, visit shows and seek the advice of a professional handler, if possible, before making a purchase.

Dogs in field and obedience trials are judged on their performance. Field trials are held for dogs bred for hunting quail, pheasant, grouse, rabbits, ducks and other upland game birds and animals. A thorough knowledge of the sport should be gained before a purchase is made. The cost for professional training, entry fees, travel, food, lodging and the time necessary for making a champion will be much more than you probably think. Talk with those who have developed a champion. After understanding bench and field trials, you may not be interested in developing a champion and decide that a good purebred meets your needs.



Figure 12- Many of the hunting breeds make excellent pets. They also serve an important role to the weekend hunter.

Indoor or Outdoor

You should give some consideration to where your dog will

spend most of its time. Dogs that spend a part of their time indoors usually have better manners than those that spend all of their time outdoors. This is because their master will teach them to stay off furniture, not to bark unnecessarily and not to greet house guests with unwarranted ferocity. This is not to say that dogs spending all of their life outdoors cannot have good manners. Lack of manners is caused by the absence of attention and proper training.

Most breeds can live healthy lives year-round outdoors. A properly designed dog house with bedding must be provided. It is important to be consistent in housing. A dog will surely suffer if its sleeping quarters are repeatedly changed from indoors to outdoors without adequate time for physiologic adjustment.

Hair Length

When selecting a breed that will spend most of its time indoors you should consider the hair length. Dogs with long hair will collect water and mud and require more brushing, bathing and combing to keep their coats clean and free of tangles. The hair they lose will be more conspicuous than from a dog with short hair. If you expect a long-haired dog to spend a great deal of its time indoors, you may want to select a rug to match the color of the dog or the dog's color to blend with the rug and more frequent vacuuming will be necessary!

Short-haired dogs can be groomed quickly with a brush and cloth. Dogs shed during spring and fall. Dogs maintained strictly indoors also will shed some throughout the year, but shedding may not be as visible. Furthermore, some breeds require professional trimming due to the type of hair coat.

Size of Home and Exercise Area

Although there are many exceptions which are obviously happy arrangements, the small to medium size breeds are recommended for small homes and exercise areas. Some of the large breeds such as Shepherds, Boxers and Great Danes require much exercise when growing up; when mature they may fit into small apartments very nicely and get along well with no more exercise than other breeds. A large dog may create the feeling of crowding a small apartment or house, especially if he is not well trained. The following are small dogs that adapt well to city conditions and apartment living: Fox Terrier, Toy and Miniature Poodles, Dachshunds, Chihuahuas, Miniature Schnauzers, Miniature Pinschers and Boston Terriers.

Age and Physical Stamina of Owner

A 12-year-old child may have a great deal of trouble in controlling a large dog. If boys and girls 10-12 years of age are planning to train a dog in obedience and compete in 4-H obedience trials, it is important that the breed be matched

with the strength of the child. A large, rough dog soon turns out to be no fun to train.



Figure 13—This boy and his puppy are well matched. Both will be receptive to training and will develop a strong friendship. Note also the correct manner which he is using to hold the puppy.

A large dog, however, can make a fine pet for a child only four or five years of age if dog and child are trained by someone capable. The large breeds can absorb the rough treatment often given by small children. The dog should understand the meaning of “No”, be taught not to jump on people and be corrected in any bad habits which cannot be tolerated in a household. Some breeds are nervous and snappy and do not easily tolerate youngsters; others are warm, friendly and protective. Some of the breeds with a good reputation for getting along with children are: Golden Retriever, Labrador Retriever, Boxer and Poodle.

Disposition Patterns

Each breed of dog as well as each individual dog has certain personality traits. Therefore, it is good to become well acquainted with the characteristics of your breed. The sporting dogs and the larger breeds of the working group have the quietest dispositions. The terrier, toy and smaller breeds of the non-sporting group are very active.

An Alarm System, Not a Guard Dog

Most breeds will serve as watch dogs and sound an alarm when strangers arrive, especially if they arrive at an unusual time or attempt entry. Burglars study homes carefully and those with dogs are usually bypassed because of the threat of detection.

Trained guard dogs are as dangerous as a loaded gun and should be owned only by those who have special needs or have had special training in handling them.

Male or Female

You will be faced with the decision of selecting a male or female puppy. Most breeds approach sexual maturity at nine to 10 months of age. Large breeds are slower to mature than small breeds. As sexual maturity develops, the advantages and disadvantages of each sex become obvious.

The male has the advantage of not coming in season twice each year. Special precautions must be taken to keep a bitch from mating when you don't want her to. The season (time during which she will attract male dogs) lasts about 21 days. If she is allowed to urinate at her regular places outside around the home, a number of males will be attracted and there may be dog fights, damage to shrubbery from urination and a generally unpleasant situation. To prevent this, the bitch must be housed so that the odor of her urine is not available to males and so that she cannot escape and get to a male. If she is a purebred and you do not intend to show her, you may have her spayed (ovaries and uterus removed surgically by a veterinarian). Spayed bitches or castrated male dogs (testicles removed) may compete in obedience trials. They may not be shown in breed shows. Animals that have been spayed or castrated sometimes have a tendency to become overweight unless their diet is controlled and they receive exercise.

The male has the disadvantage of staying away from home for several days when he finds a nearby female in season. He also is much more likely to attack other male dogs either alone or in your presence, and he may be injured or cause injury and require medical attention. His fighting may also cause distress and embarrassment.

It is not necessary for a female to have a litter of puppies before she is spayed for her to be a complete dog. Most veterinarians prefer to do the operation when the bitch is between seven and nine months of age or just before she comes into her first season.

It is also untrue that a male should be mated at least once if he is to be a completely adjusted dog. Unless you intend to use your male for stud service on a worthwhile financial basis, you may wish to have your male castrated (neutered).

Also, the male may damage your shrubbery by urinating on it. If he is not trained to stay on your property, he may damage the shrubbery of your neighbors. It has been the experience of the author that chemicals on the market for repelling dogs from shrubbery are ineffective. Good fences may be the best preventive measure.

Most Dogs Are Family Pets

Although interest in dog shows, obedience and field trials is increasing, most puppies will continue to be selected for the purpose of being a family pet. If possible try to find out if

the dam and sire of your puppy have good dispositions which may be transmitted genetically. The training and environment will, however, play a large role.

Hunting Possibilities

You may wish to hunt pheasants, grouse, ducks or rabbits; do not overlook the hunting breeds. They make excellent pets as they have quiet dispositions and show great loyalty and affection.

Age of Puppy

The age of your puppy when you obtain him is very important. You should select a puppy that is friendly and outgoing instead of one that is shy or appears frightened by a stranger. It is impossible to know which puppy of a litter might be the best at maturity. A friendly, bold puppy, however, is probably a better risk than a shy one. If purebred, it is usually best to select a puppy of medium size rather than the largest or smallest in the litter, since it is most likely to fall within the size limit of the breed. The puppy should be taken from the litter at from eight to 12 weeks of age because the puppy's personality may be developed after this age. If the puppy is taken from the litter between eight to 12 weeks and spends most of his time with people, he will prefer the companionship of humans to the companionship of dogs.

It is not wise to select a mature dog for a pet that has spent his life in a kennel and has had only limited experience with people. He will usually be very difficult to house-train and may not willingly return affection and loyalty.

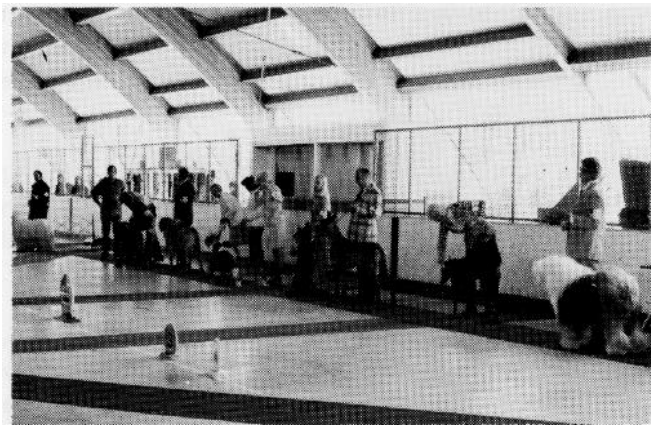

Figure 14- If you are undecided about which breed to choose, attend a dog show and see many breeds and talk to some of the exhibitors.

Attend a Dog Show and Make a Study

Personal reasons which you may be unable to describe will

probably be involved with your choice. If you have not decided, visit a dog show so that you can see a number of breeds. The breeds were developed for different purposes and therefore have different dispositions and hair coats and are different sizes and colors. Study the breed of your probable choice and learn as much as you can about the purpose for which it was bred and its general disposition. Do not be taken in by the "good deal" as you search for a pup, as you may be taking on a pet which you may have for many years. Purchase a dog with which you will always be happy.

Vaccinate Your Puppy

The mother of the puppies will normally carry immunity to distemper, hepatitis and other infectious diseases and will transmit this immunity to her puppies through antibodies in her colostrum milk which is produced shortly after whelping. To be sure the mother carries a strong immunity to distemper, a deadly killer of puppies, she should be revaccinated for distemper before breeding or according to your veterinarian's recommendation. This immunity may protect the puppies up to from nine to twelve weeks of age. Therefore, your veterinarian should be contacted as soon as you acquire your puppy in order to establish an appropriate vaccination program. Vaccinations are discussed more completely on page 28.

Registration Papers

If your puppy is purebred, the breeder should supply you with a copy of the puppy's pedigree showing three generations and an application form to register the puppy. Some breeders register the puppies at the time they register the litter. In such cases, he merely signs over the dog's registration to you. You should then have the papers transferred so that ownership is in your name.

It is important that you get the papers at the time you get your puppy. If you don't receive them at this time, you may never get them. If the papers aren't available when you get your puppy, obtain a written statement from the breeder that you will get your papers within a certain time or your money back. Many breeders may not give you the papers until the puppy is fully paid for. You may also be asked to sign a contract in which, as a condition of the sale, you agree to neuter your puppy before you receive the papers. A reputable breeder of good stock is usually honest, and will try his best to sell you the dog which will be best for you. Do not, however, expect to pay "pet prices" for "show quality". Most reputable breeders will give guarantees on all their puppies, whether for pet or show. Be sure to know about possible problems in the breed you have chosen and ask what the breeder guarantees. Such a guarantee should mean that if a problem arises, the breeder may refund part or all of your money, or even replace the dog.

Examples: Guarantee against congenital defects in all breeds

Guarantee against hip dysplasia in many breeds

Guarantee against eye defects in Collies

“Temperament guarantee” on Shepherds, Dobermans, etc.

Preparing for Your Puppy

It is really cruelty to animals not to prepare in advance for the arrival of a dog. You have many things to think about first. For example, are you going to keep your dog in the house, in the garage or in a dog house in the backyard? It should be said here that most dogs do better if they are allowed to spend part or all of their time in the house. They learn better manners, are happier and learn faster than do dogs kept tied in the yard. Hunting dogs are no exception.

If you plan to keep the dog outside, then you must consider the construction of a dog house. You may wish to tie the dog most of the time or have a run attached to the house. Your dog will readily accept either. A run is usually safer but is more expensive. A run also allows the dog more freedom. Many people make the mistake of building pens that are too large. Since dogs, except puppies, seldom exercise for their own sake, they will not use the space in big pens, but will only make it harder and more expensive to keep up.

A kennel run 10 feet wide and 20 feet long is bigger than average and will serve for most dogs. A hard surface of some type must be added to the run or the dog will live in a mud hole. Concrete is probably best as it is easy to clean and disinfect. It can also be formed for good drainage. The cost is somewhat high. Medium size “pea” gravel is also suitable, although cleaning and disinfecting are more difficult. The best fencing is steel, galvanized and woven into what is called “chain link fencing” or “cyclone fencing.” Larger mesh is unsatisfactory. Most kennel fencing should be five or six feet high, since it is necessary to prevent the dog from climbing over it. Problem climbers can be stopped by tipping the top of the fence inwards.

Sometimes it will be too expensive to have a fenced pen. In such cases, and for house dogs as well, you can put up a wire run. This is done by stringing wire from, say, the back porch to a tree in the yard. A ring is put on the wire, and a light chain is fastened to this. One end of the chain is fastened to the dog’s collar. When these are all hooked together, the dog can run from one end of the wire to the other. He can be taught to relieve himself at one end of the run. Similarly, a heavy wire or cable may be on the ground stretched between two posts. Make sure the tie chain is not too long.

Plans for building a dog house are shown on page 31.

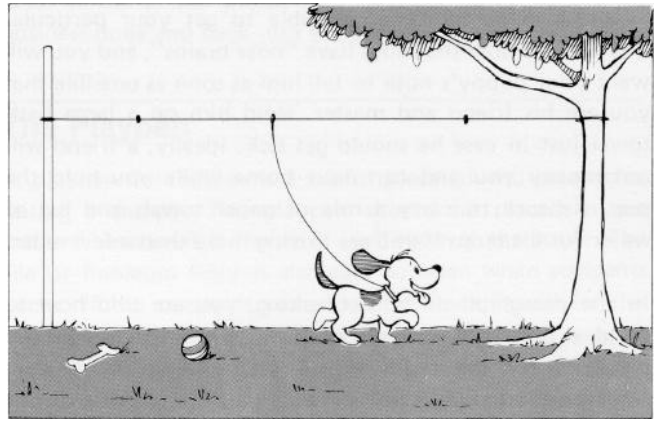

Figure 15- A light cable stretched from a tree to a post is inexpensive and handy. The wire stops located several feet from the post and tree will prevent the dog from becoming tangled. Your dog must have shade and shelter if tied outside.

If you plan to have your dog live in your home, you may wish to purchase a dog bed. They are quite attractive and come in different styles. You will also need a pan for feeding and providing water. Stainless steel pans are preferred. A leather collar and leash will also be needed. Do not purchase these items until you have your puppy to insure getting a collar that fits. Do not select a chain leash as it will hurt your hands when the puppy pulls. You also will need a brush and possibly a comb for basic grooming. The breeder will be able to recommend the type of grooming materials needed. Your puppy will enjoy rawhide toys for chewing and play. They will be helpful to you in teaching him what may not be chewed. Do not purchase indigestible toys because the puppy might swallow it when chewing.

Your First Day with Your Dog

It is most important to bring your new puppy home in the morning. It is preferable that this be on a Saturday morning, so that you will have a long weekend in which to get acquainted with the new puppy. By bringing it home in the morning, the dog will have a long day in which to get acquainted with you and will be more willing to fall asleep and settle down at day’s end.

If you have a long distance to drive with the puppy, ask the breeder not to feed it in the morning, since your puppy might become carsick during the trip home. Give your puppy his first meal in your home when he is very hungry so he will know he can depend on you. Ask the breeder for some of the puppy’s regular food so a completely strange diet won’t upset the puppy. Purchase the same kind or a similar kind and gradually change over. Ask the breeder for a feeding schedule. You may wish to bring home a jug of the breeder’s water so the puppy won’t have a sudden change to your water and possible digestive upsets.

On the trip home, hold the puppy on your lap and give him

as much opportunity as possible to get your particular odor. Remember that dogs have "nose brains", and you will want your puppy's nose to tell him as soon as possible that you are his friend and master. Hold him on a large bath towel just in case he should get sick. Ideally, a friend will accompany you and can drive home while you hold the pup. Be sure to carry a role of paper towels and jug of water for cleanups if you are driving more than a few miles.

In the paragraph on housebreaking, you are told how to build a box bed for your puppy. Presumably you have prepared for the pup's arrival by building the box in advance. You should put some of your old clothes in this

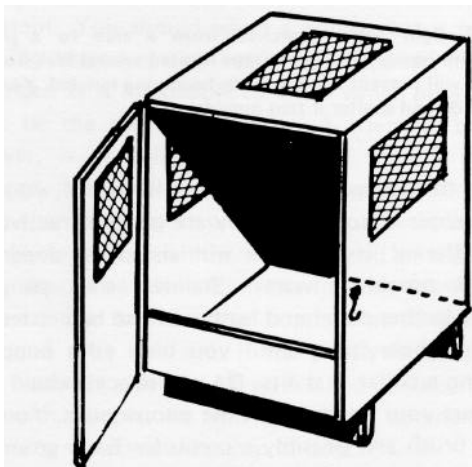

Figure 16- A box bed of this type is important to housebreaking. It should be approximately 24" long and 18" wide depending upon the breed and size of your puppy.

box so that the puppy will continue to get your smell and be comforted and assured by it. During his first day, the puppy should be taken out of doors every hour. Take him to a pre-selected spot, as pointed out in the chapter on housebreaking. Remember that you must take him out

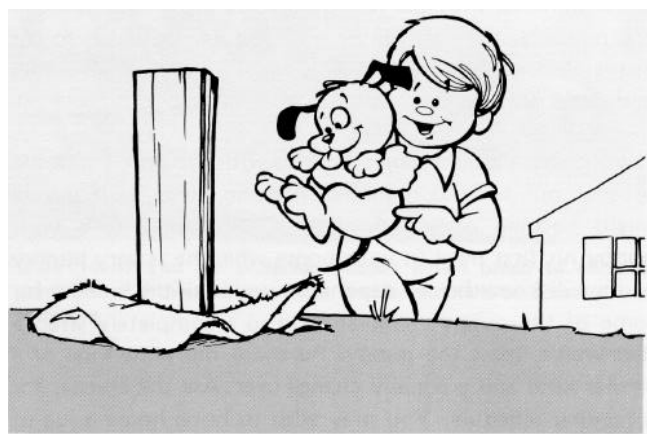

Figure 17- Fasten the cloth you used to mop up his first mistake to a stake just outside the house. When you suspect he is about to relieve himself, rush him to the area and command "business". After he has relieved himself, give much praise.

before play, after eating, when he awakens from a nap and before anything exciting is likely to happen.

When your puppy has an accident in the house, mop up the puddle with an old rag. Save the rag for a purpose discussed under housebreaking. Wash the area with soap and water.

Practically all people want to play with a new puppy. He will want to play also, but puppies tire quickly and need to rest and sleep. Do not allow family members to play with him for long periods and completely wear him out. Put him in his box bed for his naps. After the trip by car, being fed and some time for getting acquainted with the family, it will be time for his first nap. By using the box bed several times during the day for naps, it will not seem so strange to him when he is left in it overnight for sleeping.

Housebreaking Your Puppy

The success of housebreaking is based on the instinct of den dwelling animals to keep their beds clean. You may create a den or home for your puppy by constructing a box bed as shown in the diagram. The box should be large enough for the puppy to turn about in and lie at full length, but should not be larger. Expanded metal or heavy wire mesh should be placed on the door and sides to allow the puppy to see out and provide ventilation. Even a very young puppy will soon learn to respect his bed. He will not make a mess in his bed where he must sleep. He may get caught the first night, but he won't the second. However, if the box is so large that he can relieve himself in one end and sleep in the other, he will do so. When the puppy outgrows this box, you may change him over to using his permanent dog house or a crate if he will be kept indoors.

Newspapers are probably the best for laying on the floor of the box bed. If a blanket is used, it will be scratched into a lump and not cover the floor as well as paper. Paper is also disposable and will help to keep the box clean.

The first night with your puppy can be trying. When the family is ready for bed, take the puppy outside so that he may relieve himself. Be sure that he does relieve himself as this is the time to form the habit.

When you put him to bed for the night, he will be lonely and will likely begin to bark and howl. Your job is to ignore this. He will soon cry himself to sleep. If you pay no attention, the puppy will learn after a night or two that crying accomplishes nothing and will stop. If he persists and you think you can't stand it or the neighbors can't, it sometimes is necessary to open the box and give the puppy a scolding. Do not cuddle him. You want him to realize you do not like him to cry.

After the puppy has been put to bed, do not give in and let him out of the box. If you give in once, you are on the road

to mistakes and so is your pup. The same applies when he awakens at 4:00 a.m. Don't give in. He must learn to control his kidneys and bowels, as well as his loneliness. If you give in once, the job gets harder and finally impossible. You should be as considerate as possible and let the puppy out to relieve himself by 6:00 a.m. After a couple of weeks, depending on the age of the pup, you can extend this time at least one hour. The restriction of food and water three hours before bed time will also help him in controlling his kidneys and bowels.

When you take your puppy outside to relieve himself, take him to a place that you have pre-selected. Mark this spot by anchoring the piece of cloth that you used in mopping up his first mistake. The puppy will smell where he has been before, or thinks he has, and get the idea immediately. When he is about to relieve himself, use the word command, "business".

There will, of course, be some mistakes in the house. When this happens, scold him and take him outside where he should have gone. After a mistake, always wait until he does relieve himself outside before bringing him back into the house. It is very important to watch your puppy closely during the first week to avoid mistakes in the house. During the first three or four days, take your puppy outside about every hour. If you think he is about to have an accident, quickly take him outside.

Most people who have difficulty in housebreaking their puppies do not follow these instructions closely. They may



Figure 18—A litter of puppies can be fun, a lot of work, and it is sometimes hard to find homes for them. Do not breed your bitch unless you have firm orders for the puppies.

decide that the weather is too cold or it is raining and thus confuse the puppy with inconsistency. If the weather is

cold or rainy, the puppy will be in a hurry to get his business done and back into the house.

The Playpen

A playpen for babies is a useful piece of equipment for raising a puppy. The playpen should be placed in the kitchen because it is the most used room in the house. The tile or linoleum floor is also easy to clean when accidents occur. If the puppy is placed on the floor, it will wander throughout the house, thus requiring much time in keeping track of it. If you do not use a playpen, place a board at the door leading from the kitchen so that the puppy cannot get off the kitchen floor. A playpen provides plenty of space for the puppy to exercise but also controls his activity. The playpen floor is also fairly easy to keep clean. When the puppy outgrows the playpen, he may be placed outside in his run or tied by a collar as you have previously decided.

The box bed should be placed in the garage or some other quiet place. Your puppy will learn to appreciate this privacy. He should definitely not be allowed to sleep in the owner's bedroom or on a chair or couch. Dogs that have this privilege frequently develop poor personality traits and do destructive things when left alone. Even young puppies have a pack instinct and recognize a leader. If you do not establish yourself as the leader and supervise the dog, the dog will claim the leadership and will make certain demands that will cause great conflict in a home.

Feeding Your Eight- to 12-Week-Old Puppy

Ask the breeder for enough dog food to feed your puppy for the next couple of days. Be sure to understand how your puppy has been fed. Beginning the second day, gradually change to the puppy food you will use. After three or four days the pup should be completely changed over. If a dry food, add enough liquid based upon package instructions to partially moisten it. Feed the puppy morning, noon and evening. Feed what the puppy will clean up in about 15 minutes. Dry food for puppies and dogs is much more economical than canned or semi-moist burgers. The caloric value is much greater per pound because it contains much less water. It is important to get your puppy on the dry type at this time as he will then eat it with enthusiasm throughout his life. A high-quality balanced puppy ration is best because puppies require extra protein, calories, vitamins and minerals for proper growth.

Feeding the Mature Dog

A major factor in maintaining a healthy dog is proper feeding. For good health the dog requires a daily ration of

proteins, carbohydrates, fats, vitamins, minerals and water in adequate and proper proportions. Dogs which do not receive a balanced ration may suffer from nerve and muscle disorders, skin disorders, diarrhea, fatigue, low reproductive efficiency, emaciation and many other diseases and impairments. Proper feeding will help make your dog more enjoyable and increase his years of living a healthy life.

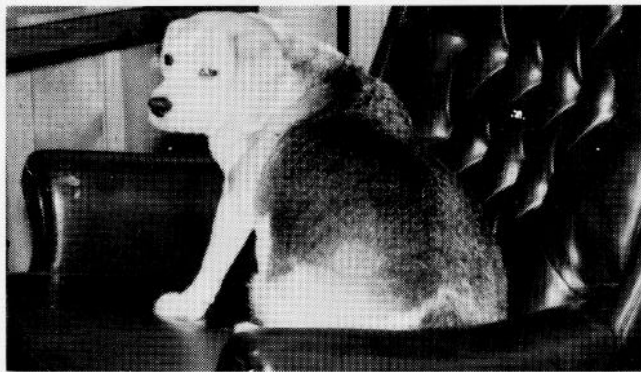

Figure 19- Over feeding and feeding between meals will cause your dog to be overweight. Obesity adds stress to the body and will shorten your dog's life.

Prior to 1945 most dogs were fed table scraps or home formula food consisting of a wide range of products. Cheap cuts of meat occasionally supplemented their diet.

Today, because of scientific study and modern technology of animal and livestock feed preparations, one may feed the dog properly and with ease by using commercially prepared food. Because of the extra effort and cost of securing, mixing, and storing, few people attempt to mix their own rations. Dogs are carnivorous (meat eaters) by nature, but they can use a wide variety of cereal and other food stuffs. If foods high in starch such as cornmeal, oatmeal, potatoes and other cereals are added to the ration, they should be cooked because raw starch can cause diarrhea.

Some dogs, with the encouragement of their owners, become fond of ice cream, candy, beverages and other foods which dogs normally do not prefer. These foods encourage the dog to be a finicky eater which may ultimately lead to a nutrition problem.

Some families with intentions of feeding their dogs only the very best ration feed primarily an all meat diet consisting of various cuts of meat they may find on sale. A diet of this type is not only unbalanced, but costly. Meat is low in calcium and high in phosphorus. Over a period of time calcium will be reabsorbed from the bones causing them to be weak, and also may cause loosening of the teeth. Wild

animals that subsist primarily on meat also devour the bones which are high in calcium, thus balancing the calcium and phosphorus in their diet.



Figure 20- A healthy dog is a properly fed dog.

Rations prepared commercially that are advertised as "all meat" usually have mineral and vitamin additives, which make them complete rations. Check the label, making sure it states complete and balanced nutrition. These rations are perfectly safe to feed.

Commercial Dog Food

Commercially prepared dog food comes in dry, semi-moist and the canned or wet form. The dry form may be meal, expanded pellets or crumbles. The semi-moist is in the burger or patty form and the wet is canned. It is important to have full knowledge of them because their food value, moisture content and cost per pound vary greatly.

Commercial dog food is recommended because it contains all the required nutrients in their proper balance. It would be quite difficult to formulate a dog ration containing all of the required nutrients from table scraps and other foods with assurance that all the requirements had been met. Commercial dog food has good keeping qualities and enables one to maintain a dog in good health with relative ease.

How Much to Feed

Feeding a dog properly is complicated by the variations in size, activity and disposition; all of these affect his requirements for energy and other required nutrients. Puppies, small dogs, pregnant and lactating bitches have a higher calorie requirement per pound of weight than larger dogs.

Because of differences in activity and disposition, it is not uncommon to observe dogs of the same breed and size cared for under apparently the same environmental conditions requiring different amounts of food for maintenance. Feeding for good health thus requires the attention of the master. The requirements listed in Table 1 are meant to serve as guides. Dogs are most attractive when they are neither too fat nor too thin. Do not feed more than what he will clean up in 15-20 minutes. Discard any uneaten food and wash the food container after each meal. Always provide plenty of fresh water.

Table 1. Simplified and Detailed Explanation of Daily Food Requirements for Adult Dogs

Dog's body weight in pounds	Calories needed for each pound of body weight	Daily rations of dog food		
		Dry food	Packaged semimoist	Canned
5	50	3 1/2 oz	5 oz	10 oz
10	42	5 1/2 oz	9 oz	18 oz
15	35	7 oz	11 oz	22 oz
20	34	9 oz	13 1/2 oz	27 oz
30	31	12 1/2 oz	18 1/2 oz	37 oz
45	28	17 oz	25 oz	51 oz
60	26	21 oz	31 oz	62 oz
75	25	25 oz	37 1/2 oz	75 oz

NOTE: Modification of requirements of National Research Council recommendations by the Cornell Research Laboratory for Diseases of Dogs.

When to Feed

Full grown dogs or those one year of age or more should be fed only once per day. Some large or giant breeds or heavy eaters should be fed twice daily. You may decide the most convenient time and then continue on the schedule. Dogs should be fed the same time each day since, like humans, they are creatures of habit. Hunting dogs should be fed at night as they will perform better if they have had time to digest their food before hunting.

If your dog is a poor eater, you may need to encourage him with praise when eating. Stirring the food and holding the food dish for him may also be of help. This bit of extra attention may pay off with a poor eater. Do not do this unless necessary, or often, as he may learn to depend upon your attention.

Feeding the Stud Dog

The stud dog does not require a special diet or supplement. His physical condition is important, and you can control

this by either enforcing or limiting his exercise and feeding a proportionate amount. A stud dog will be more effective as a breeder if he receives enough exercise to have good muscle tone. A dog that is too fat will not be aggressive and is likely to be an ineffective breeder.

Feeding the Hunting Dog

Most hunting dogs are used for hunting only one or two days per week because their masters do not have more available time. For top performance, a hunting dog must go through a training period to get into physical condition to meet the strain of the hunting season. Dogs in training or when hunting expend much more energy than they do when only serving as a family pet. During the first few days of vigorous work, they will lose weight rapidly. They may expend more energy than they can obtain from their regular ration. This can be avoided by adding lard or bacon grease to the ration. Fat is high in energy and will offset the expended energy. No more than 3-5 percent should be added as it may cause diarrhea and upset the diet's nutritional balance. Also, many owners of hunting dogs change to a more dense food with higher protein and energy during the working period.

Feeding Table Scraps

Table scraps may be added to dog food and serve a useful purpose. Table scraps are mainly carbohydrates, meat trimmings, greases and gravies which are low in protein, vitamins and minerals but are high in energy and fat content. Dogs will usually eat commercial food with more relish if table scraps are added. This is not to say that table scraps must be added. Many people are frugal and really want to feed their table scraps. However, if scraping them together and adding them to the ration is bothersome, their economic value is probably not worth the extra effort. If you have an irregular amount of table scraps or if you have several dogs and do not have enough for all of them, you should not add them. Feeding them on an irregular basis will cause your dog to pick at his food when they are not added. Table scraps should not be added in excess of 10-15 percent in order to avoid unbalancing the ration.

Table scraps or special dog treats should not be fed between meals as they may cause your dog to become a finicky eater or become overweight.

Food from the table should never be offered to the dog meal time. It may be amusing to see a puppy show a winsome face and perhaps nearly talk in asking for food; however, this amusement will be short lived and there is nothing amusing about a grown dog begging and jumping for food from the dining room table. The same remarks hold true for outdoor living and picnics. Exceptions cannot be made if compatibility of family living and keeping a dog is to be maintained.

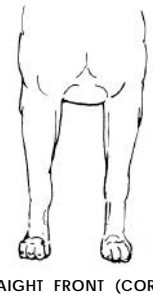
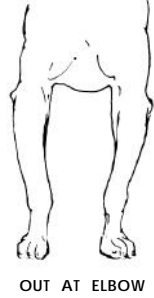
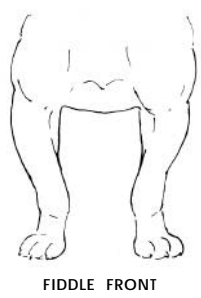
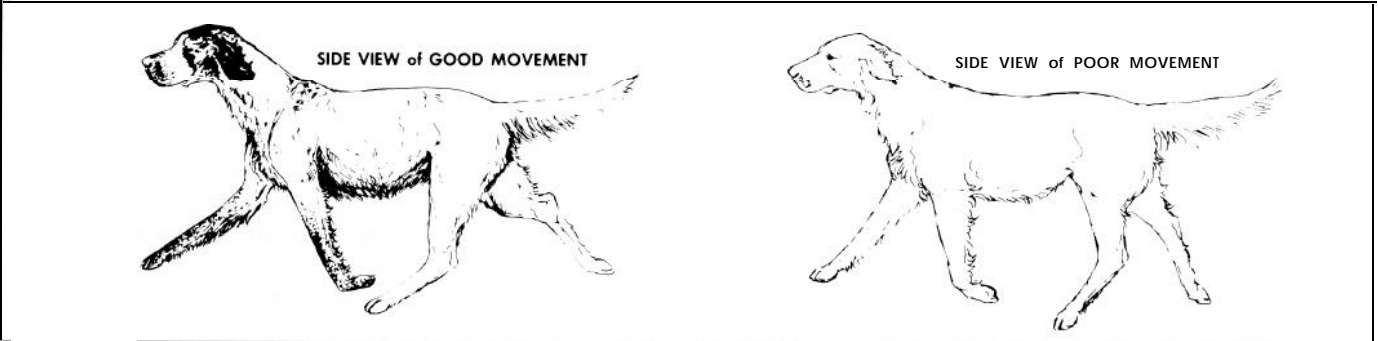
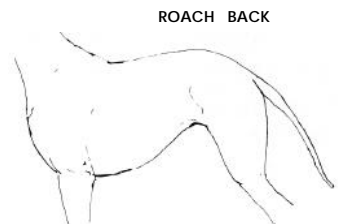
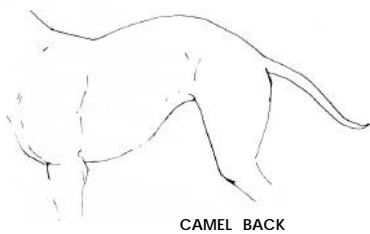
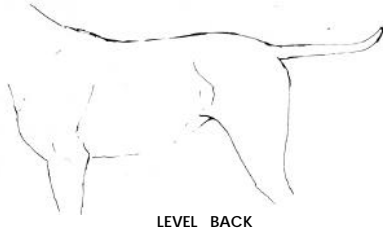
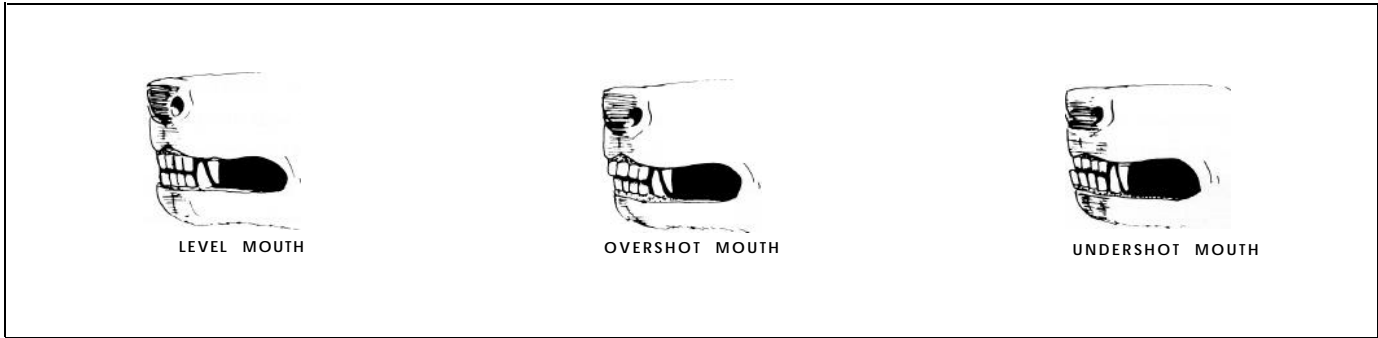

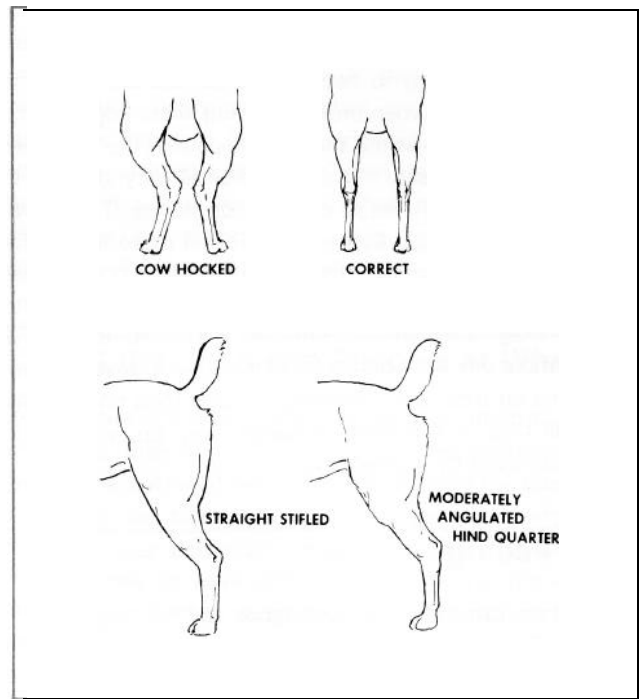
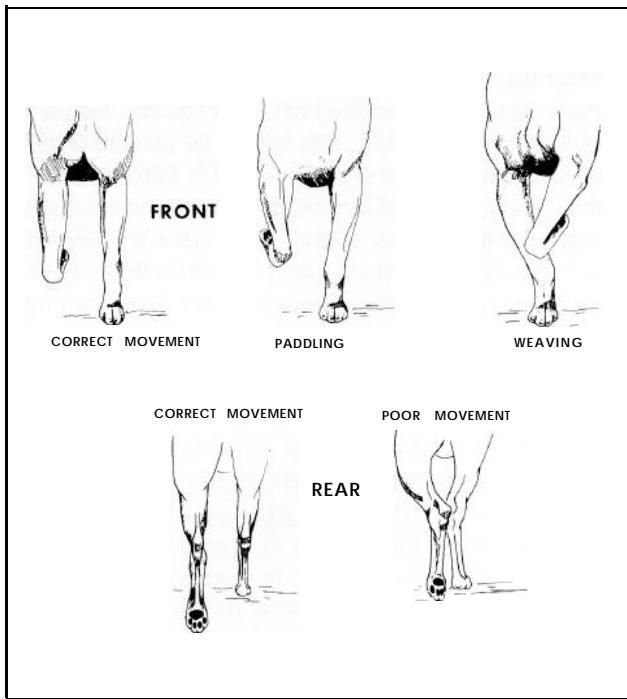

Sixty-three Day Whelping Table

Service Whelping	January	1 2 3 4 5 6 7 8 9 10 11 12 13 14 15 16 17 18 19 20 21 22 23 24 25 26 27	28	29 30 31
	March	5 6 7 8 9 10 11 12 13 14 15 16 17 18 19 20 21 22 23 24 25 26 27 28 29 30 31	Apr. 1	2 3 4
Service Whelping	February	1 2 3 4 5 6 7 8 9 10 11 12 13 14 15 16 17 18 19 20 21 22 23 24 25 26	27 28	
	April	5 6 7 8 9 10 11 12 13 14 15 16 17 18 19 20 21 22 23 24 25 26 27 28 29 30	May 1 2	
Service Whelping	March	1 2 3 4 5 6 7 8 9 10 11 12 13 14 15 16 17 18 19 20 21 22 23 24 25 26 27	28 29	30 31
	May	3 4 5 6 7 8 9 10 11 12 13 14 15 16 17 18 19 20 21 22 23 24 25 26 27 28 29 30	June 1 2	
Service Whelping	April	1 2 3 4 5 6 7 8 9 10 11 12 13 14 15 16 17 18 19 20 21 22 23 24 25 26 27	28 29	30
	June	3 4 5 6 7 8 9 10 11 12 13 14 15 16 17 18 19 20 21 22 23 24 25 26 27 28 29 30	July 1 2	
Service Whelping	May	1 2 3 4 5 6 7 8 9 10 11 12 13 14 15 16 17 18 19 20 21 22 23 24 25 26 27	28 29	30 31
	July	3 4 5 6 7 8 9 10 11 12 13 14 15 16 17 18 19 20 21 22 23 24 25 26 27 28 29 30	Aug. 1 2	
Service Whelping	June	1 2 3 4 5 6 7 8 9 10 11 12 13 14 15 16 17 18 19 20 21 22 23 24 25 26 27	28 29	30
	August	3 4 5 6 7 8 9 10 11 12 13 14 15 16 17 18 19 20 21 22 23 24 25 26 27 28 29 30	Sept. 1	
Service Whelping	July	1 2 3 4 5 6 7 8 9 10 11 12 13 14 15 16 17 18 19 20 21 22 23 24 25 26 27	28 29	30 31
	September	2 3 4 5 6 7 8 9 10 11 12 13 14 15 16 17 18 19 20 21 22 23 24 25 26 27 28 29 30	Oct. 1 2	
Service Whelping	August	1 2 3 4 5 6 7 8 9 10 11 12 13 14 15 16 17 18 19 20 21 22 23 24 25 26 27	28 29	30 31
	October	3 4 5 6 7 8 9 10 11 12 13 14 15 16 17 18 19 20 21 22 23 24 25 26 27 28 29 30	Nov. 1 2	
Service Whelping	September	1 2 3 4 5 6 7 8 9 10 11 12 13 14 15 16 17 18 19 20 21 22 23 24 25 26 27	28 29	30
	November	3 4 5 6 7 8 9 10 11 12 13 14 15 16 17 18 19 20 21 22 23 24 25 26 27 28 29 30	Dec. 1 2	
Service Whelping	October	1 2 3 4 5 6 7 8 9 10 11 12 13 14 15 16 17 18 19 20 21 22 23 24 25 26 27	28 28	30 31
	December	3 4 5 6 7 8 9 10 11 12 13 14 15 16 17 18 19 20 21 22 23 24 25 26 27 28 29 30	Jan. 1 2	
Service Whelping	November	1 2 3 4 5 6 7 8 9 10 11 12 13 14 15 16 17 18 19 20 21 22 23 24 25 26 27	28 29	30
	January	3 4 5 6 7 8 9 10 11 12 13 14 15 16 17 18 19 20 21 22 23 24 25 26 27 28 29 30	Feb. 1	
Service Whelping	December	1 2 3 4 5 6 7 8 9 10 11 12 13 14 15 16 17 18 19 20 21 22 23 24 25 26 27	28 29 30 31	
	February	2 3 4 5 6 7 8 9 10 11 12 13 14 15 16 17 18 19 20 21 22 23 24 25 26 27 28	March 1 2 3 4	

SOURCE: The American Kennel Club, *The Complete Dog Book*

Feeding Bones

Don't allow your dog to have any small bones. Fowl and chop bones splinter when broken, leaving sharp edges which may become caught in the throat or impact in the intestines and cause great misery. This impaction is very difficult to treat. Dogs obviously enjoy chewing on bones. Those that live outdoors enjoy burying them and often make trouble for the gardener in the family. The only safe bones to provide are knuckle and leg bones which are too large for the dog to splinter. Dogs that are fed primarily soft food for several years without any large bones for chewing may develop tartar and stains on their teeth. Feeding dry dog food on a regular basis will help. If the tartar is heavily built up, you should have it removed by a veterinarian.

Self-Feeding

Self-feeding can save time and labor for the large kennel operator. For the family with a family pet it may also prove extremely handy and time saving. However, feeding is often a time when there is mutual admiration between master and dog, and these moments should not be denied either party. This method of feeding may prove especially useful when you plan to arrive home late and would not be able to feed at the usual time. It may also be a good method for dog owners who spend irregular hours away from home and cannot easily give regular attention to the dog.

Self-feeding is simply providing commercial dog food, dry type, in a self-feeder, along with plenty of fresh water. Puppies may be placed on a self-feeding program at about 12 weeks of age. Make the change gradually from dampened dry food by reducing the amount of liquids added.

You may purchase a self-feeder from a farm supply store. Most of the chicken feeders work quite well, or you may build your own from sheet metal and wood. It must be kept in a place accessible to your dog and where it is dry. Dogs will regulate their diet and generally maintain themselves in a lean, trim condition. If the dog becomes overweight, this feeding program should be changed.

Breeding

Selective breeding of dogs is fascinating not only to the breeder who earnestly tries to improve the dogs and the breed but also to the hobbyist who has a good female and is interested in raising a litter of puppies. One can make progress faster with dogs than most domestic animals because of the young age at which they reproduce and the number of young they whelp. A bitch may whelp as many as 12 puppies at 15 months of age compared to a single birth in cattle at 24 months and horses at 36 months. Dogs also cost much less than cattle and horses.

It should be mentioned at the outset that the hobbyist usually does not make a large profit from the sale of a litter. The breeding fee, cost for veterinary attention, along with cost of puppy food and advertising of a litter, quickly reduce the profit to a minimal amount. The market for puppies is sometimes weak, and one can sometimes be left with a sizeable litter that soon eats up the profits. The amount of care, space and sanitary facilities for a litter of puppies is surprisingly large. This is not to say that a profit cannot be made, but one should be discouraged from plans for quick and easy profits from the sale of puppies.

Another precaution is for indiscriminate reproduction. The world does not need more dogs. Dog shelters continue to overflow with unwanted dogs and puppies. Many of these animals were produced because of neglect by their owners. Some of the owners have little or no knowledge of reproduction in dogs and allow their pet to roam the neighborhood during time of estrus. Mixed-breed puppies are usually in poor demand and off they go to the dog shelters to be fed and then destroyed. This is the most civil ending for unwanted puppies. Many so called "pet lovers" abandon their dog when they tire of the animal. Then it must steal food, suffer from cold, heat and lack of water and medical attention. Dogs reproduce in spite of these difficulties. Many nearly starve to death and eventually end up at the dog shelter. If you have any doubts of the validity of these statements, visit a dog shelter and talk with the manager.

Raise a litter of puppies only if there is demand for them and you have a bitch that is both a good representative of a breed and has a good disposition. Demand for a certain breed is sometimes very strong, and indiscriminate breeders mate as many of their females as they can, literally turning their operation into a puppy factory. This usually causes a sharp decline in demand because many undesirable females were used for breeding puppies. Their faults in conformation and disposition are multiplied, and the development of the breed is set back. Only good animals should be used for reproduction.

Detecting Estrus or Heat

Estrus, the period of sexual heat in the female, will come to small breeds at from six to 12 months of age and eight to 18 months in the large, slow-maturing breeds.

The first indication of heat is swelling of the vulva. A few days later there will be a bloody discharge and pronounced swelling of the vulva. After three or four days the discharge will recede or stop. The entire time is normally 21 days, with a variation of about three days.

The first seven or eight days after the show of blood the bitch usually will not accept the male. However, the males

will be strongly attracted to her. If she is allowed outside for bathroom duties, a number of males will check by each day. From the 10th to the 14th day or perhaps a day or two sooner or later, her sexual desire will be intense and she will willingly receive the male. Most breeders mate their bitches on the 10th or 11th day after the first show of blood. One mating (the male and female tied together) may be sufficient to insure pregnancy, but a second breeding two days later is preferable.

During this period of intense heat one must take extreme caution to prevent a bitch from being bred. She will try to slip through the door at feeding or climb over or under a fence to escape to a male.

After about the 14th day the vaginal discharge will stop, the vulva will return to normal and she no longer will be interested in males. However, the males will be interested in her until about 21 days.

If the bitch must be taken some distance for breeding, transportation should be made soon after the first sign of blood. This will allow her to settle down and become accustomed to strange surroundings before she comes into heat.

The bitch normally will come into heat about every six months, although it varies widely with individuals. About three estrus cycles every two years are typical. Most breeders do not breed their virgin bitches until their second heat or later, if they are not full grown.

Selecting a Sire

Selecting a sire can be as complicated as selecting a bitch puppy. You must consider the same points of conformation, disposition and instincts such as hunting and retrieving. Select a male that has strong points which may improve the weak points of your female. To learn how he transmits, you should see as many of his offspring from different females as possible. The appearance of the male is not always indicative of his offspring. Consider the male's age, his care and training or lack of training.

Remember that each parent can contribute 50 percent of the genetic make-up to the litter of puppies. A grandsire or granddam, even though of great fame, will make a small genetic contribution. Spend some time selecting the sire well in advance of breeding time.

Difficult Matings

A male or female that is being mated for the first time may be hesitant. If the female will not stand or hold still, it will be necessary to restrain her in position for the male. Muzzle her for protection from biting. A person may be needed on

each side to restrain her. An inexperienced male, or one that does not show a strong interest, should at first be used only with an experienced female that will accept him. A female that fights and repulses an inexperienced male should be avoided. An inexperienced male that has difficulty in making entry may need assistance. Guide the penis by holding the sheath. You may learn of other techniques by talking with dog breeders and kennel operators. A whelping table follows:

Care of the Bitch and Puppies at Whelping

Most bitches will whelp and care for their puppies with no help other than your providing a suitable environment for them. As a matter of fact, if all is going well the less you do the better the bitch will like it, as she will perform her duties to near perfection based on nothing but instinct. Some bitches do have difficulties; therefore this information will be slanted to guide you in providing a suitable environment and avoiding difficulties.

A Place to Whelp

The bitch should have two or three weeks to become familiar with the surroundings where she will whelp. A whelping box as shown in the illustration may prove useful if placed in an area that is warm, quiet and secluded from people, other dogs and noises. By placing a blanket on which she sleeps or part of the bedding from her house into the whelping box, you can usually coax her into sleeping in the whelping box before whelping time. Start using newspapers for bedding as they will be useful at whelping time. Care should be taken on type of bedding used for pups. Shredded paper or carpet attached to a frame are good choices.

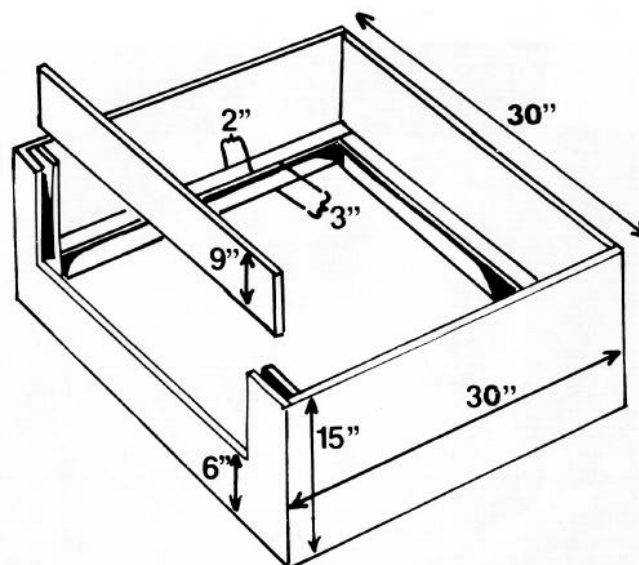

Figure 22- A Whelping Box. The 2" board on the inside of the box will prevent the mother from lying on a puppy. The board should go around the entire inside of the box. This size is suitable for small breeds. Construct it large enough to allow the bitch to stretch out flat and be comfortable.

When?

Normal gestation is 63 days. If she goes three or four days over, do not be alarmed. After the fourth day you should inform your veterinarian.

By the fifth week of gestation she will show signs of preparing. She will be heavier, her stomach will be larger, her back may be lower, her teats larger and she may lie around more. An alert dog handler will notice these changes and may predict whelping in about four weeks.

Signs of Whelping

Normal temperature for dogs is 100.5° to 102.5°F. By taking the rectal temperature of the bitch daily during the last week of gestation, one may determine within a 12-hour period when whelping will occur. It may be signaled by a drop in her normal temperature of one or more degrees. This will not hold true with all dogs. Closer signs of approaching labor are: great restlessness, relaxing and swelling of the external genitalia and a desire for seclusion.

Active Labor

Just before going into labor the bitch will shiver, pant, scratch and tear up the newspapers you have put down for her nest and show obvious discomfort. Labor has begun when she has uterine contractions, which are indicated by straining as if trying to have a bowel movement when in a constipated condition. A puppy should be born within 20 minutes to one hour after the start of labor.

If a puppy does not appear within an hour after the beginning of active labor, you should call your veterinarian.

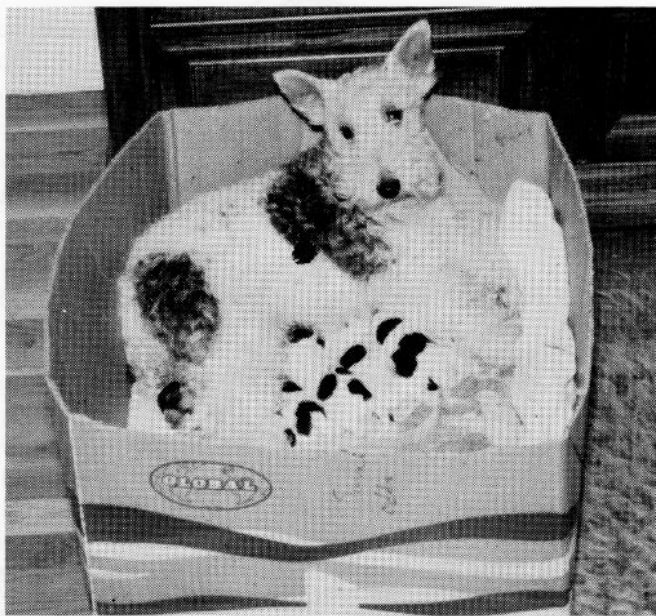

Figure 23- A large cardboard box may be sufficient if your dog is not large and if your facilities are limited.

The Newborn Puppy

The newborn puppy, enclosed in a membrane sac (called the placenta), may be born either head or backend first with the feet coming first. The bitch will break the membrane with her teeth, releasing the liquid inside. If she does not break the membrane soon, you should do it for her because the puppy cannot breathe in the liquid. She should also cut the umbilical cord. If not, you should do it for her. Before you cut the cord you should tie a piece of cotton thread very tightly around it, about 1½ inches from the pup. Then cut the cord on the mother side of the tie.

The dam will clean the puppy by licking it. When cleaning it she will also roll it around some, which also will stimulate respiration and circulation. Each succeeding pup should take no longer than one hour to be born. If there are many pups the whelping box will become very wet. Clean, dry newspapers should be substituted for the wet papers if they can be exchanged without disturbing the dam. It is of utmost importance that the pups do not become chilled. A puppy that becomes thoroughly chilled will often die. The whelping area should be warm with no drafts. A heat lamp placed several feet above the puppies will be very useful in keeping them warm.

Normally the bitch will eat the placenta in the process of cleaning up each puppy. This is a natural act and is thought to be an instinct held over from the days of living in the wild when anything left would be a sign of a new family to prowling predators. The eaten placentas may give her a black, diarrhetic stool for several days after whelping. This act of nature is beneficial to the bitch as a loose stool at this time is much better than constipation.

After whelping she will need to urinate. However, she will not want to leave her new pups and may have to be carried or led outside.

Colostrum is rich in antibodies which provide passive immunity to the pup for the diseases for which the bitch carries immunity. If the bitch is revaccinated for distemper, hepatitis and leptospirosis *before* breeding she will likely have a high titre of antibodies and transmit immunity to her puppies through her colostrum milk, therefore it is very important that the puppies receive this colostrum milk early.

The pups should be handled as little as possible until they open their eyes at about 14 to 21 days after birth. They need warm, dry, peaceful surroundings and plenty of sleep. Most dog mothers do not like anyone to handle their puppies at this age. Weigh each puppy after birth when the puppies are dry. Weigh them each day when the dam is taken out to make sure each puppy continues to gain. If a puppy is small at birth and needs supplemental feeding, follow instructions for hand feeding on page 24.

Difficulties That May Arise

If the bitch disregards the puppy at birth, you must break the membrane and tie off the umbilical cord as discussed earlier. Then dry the puppy with a towel and stimulate respiration and circulation by gently moving it from hand from hand. If it does not start breathing, open its mouth and make sure it is free of any membrane or fluid. If it seems to be filled with fluid, hold its head and body firmly, head pointed down, then jerk the puppy downward and stop suddenly as though you were shaking down a thermometer. This should cause any liquid to come out.

Some bitches may whelp the first puppies quickly and easily and then have several puppies that come slowly. One should note the start of each new labor. If a pup gets caught during birth, partly in and partly out of the vagina, wait a moment to see if the next few contractions will expel it. If not, grasp the exposed part, using a towel to give your hands more traction, and then pull outward and down when the bitch strains, letting up on the pull between strains.

Breech births (pup coming backend first with legs folded up against body) are rare. They are often difficult and may need the assistance of a veterinarian.

Occasionally a bitch will whelp very easily up to the last pup, retain it and cease labor. Watch her actions after she is apparently through whelping. If she seems uneasy and does not settle down within two hours after she has finished, suspect that she is retaining a pup and call your veterinarian.

Sometimes part of a placenta may be retained. Look for a complete placenta to be expelled with each pup. If you remove them for discard, count them. If a placenta remains inside, your veterinarian must remove it.

Mastitis in dogs is not common, but may occur. The signs of mastitis are breast swelling and hardness and fever.

Feeding of the Bitch and Puppies

The goal of every breeder should be to improve the breed through matings and see that each live puppy develops fully and expresses his full genetic potential. To meet this goal one must provide a good environment and proper nutrition. To keep mortality low, it is important that the breeder quickly recognize a weak puppy, a mother that is not producing enough milk, or other difficulties. This attention to details will pay big dividends in puppy raising as in most other livestock enterprises.

The feeding of a bitch really begins when she is conceived as an embryo. Her mother must be fed properly if she, as an

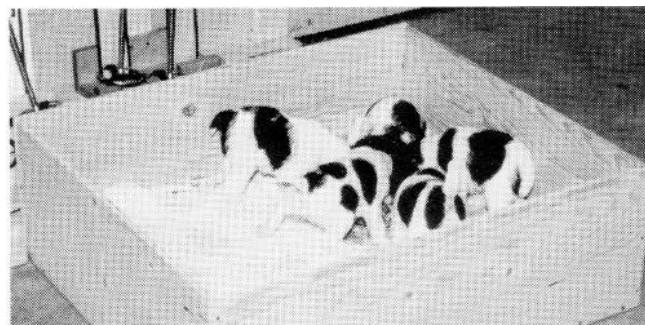

Figure 24- Feeding Puppies. In one-half of the box place a piece of cloth for them to lie on while sleeping with papers in the other half. The puppies will use the papers for bathroom purposes and will sleep in the other half.

unborn puppy, is to develop fully. She must be provided with a suitable environment and feeding program to express her inheritance for growth and in turn raise a litter of puppies. The cycle then repeats.

Let us begin this discussion by starting with the bitch to be bred. Most breeders breed their bitches for the first time at their second heat period. The bitch should be fully grown by this time, or she should be held over again. About two weeks before you expect her to come into heat increase her feed by five or 10 percent. This will stimulate both her coming into heat and ovulating, so that she may have a larger litter.

After breeding, return to her regular amount of ration for the first month. At this time she will start to increase in weight. Her back may drop some. She will likely show a change of mood, lying around more and behaving in a more calm and settled manner. About the 6 - 7 week of gestation period gradually increase her ration so that at the time of whelping she will be consuming 25 to 30 percent more food. She should not be fed this extra amount if it causes her to become fat since this may increase the possibility of difficulty in whelping.

After whelping, give her all the food she wants. When nursing her puppies, she should be fed three times per day and can consume two to three times her ordinary amount. She will wean the pups at five to six weeks. Reduce her feed as she starts weaning them. This will help reduce her milk flow and her teats to normal size.

Feeding Puppies

Each puppy should receive colostrum milk (the first milk produced by the mother after whelping) as soon after birth as possible. The milk will contain more antibodies, and the pup will be able to absorb them more completely if it nurses soon after birth. Antibodies provide passive immunity to the pups for the diseases for which the bitch carries immunity such as distemper, hepatitis and leptospirosis. For this reason, many breeders like to see that each

pup nurses before the next is born. Nursing also stimulates contractions for birth of the next puppy or the afterbirth.

After all the puppies have been born, weigh each puppy and identify any small or weak puppies. Continue to weigh daily, keeping accurate records so you can tell if a pup is not gaining.

The puppies should open their eyes at about 14 to 21 days of age. After they have opened their eyes, they should be offered a gruel of pablum and milk. The use of nonfat dry milk or skim milk may replace the whole milk if the puppies' stools become loose. Feed the puppies three times per day (from a flat pan with low sides) what they will clean up in about 10 minutes.

They will soon learn to eat if you put their noses in the food. Feed moistened puppy food sold by most commercial dog food companies at will until they are weaned--6-8 weeks. After that the puppy food can be either wet or dry. Feed them three times a day until they are six months old. After that feed the puppies food twice a day until they are 12 months old. At that time change to commercial adult dog food and feed only once a day.

Tube Feeding of Puppies

Supplementary feeding is recommended when newborn puppies are not nursing properly, when the dam is unable to provide a sufficient quantity or quality of milk, or at any time when the dam or puppies are debilitated from stress or disease. Techniques for feeding puppies include dropper, baby bottle, spoon or tube feeding.

A number 10 catheter or a small semi-rigid tube that can be passed easily into the puppy's stomach attached to a 10 to 50 ml plastic syringe may be purchased at most drugstores. Calculate the depth of insertion of the tube for each puppy to be fed as shown in the picture. Mark the tube with adhesive tape at a point three-fourths the distance from the puppy's nose to his last rib. This insures that the milk will be delivered into the stomach.

Hold the puppy in your left hand and gently pass the tube over his tongue up to the mark. Slowly release the formula and withdraw the tube. As the puppy grows, the tape can be moved so the tube can be inserted further. Use a disinfectant to flush the tube and syringe after each feeding. Be sure to rinse thoroughly after disinfecting.

You can purchase a commercial milk replacer or in an emergency you can make your own replacer. You will need one cup of milk, three egg yolks (no egg white), one tablespoon of corn oil, one drop high quality oral multiple vitamin and a pinch of salt. Mix-blend uniformly and warm to 95-100°F

(near human body temperature) for puppies less than two weeks of age.

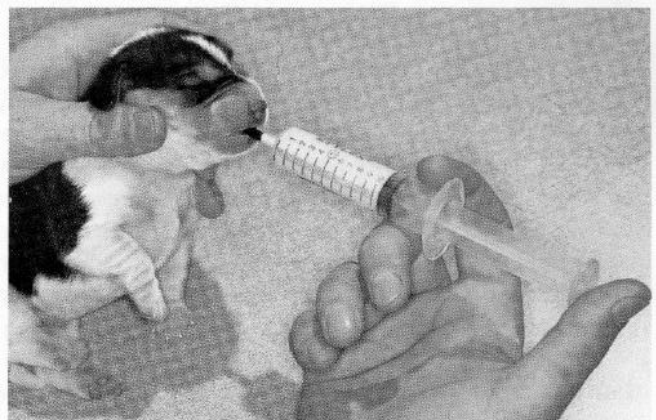
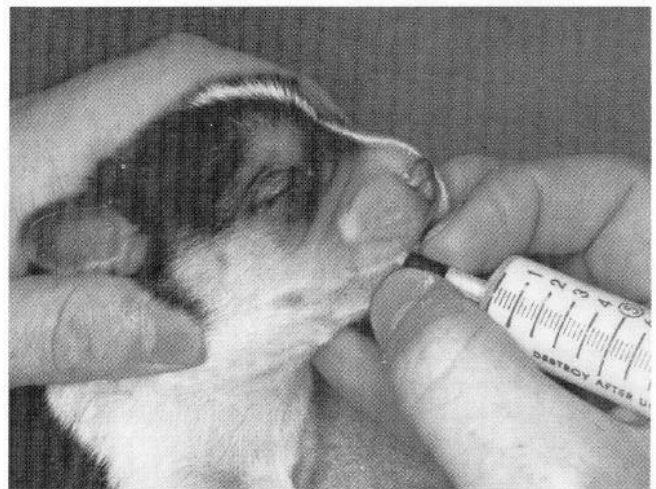
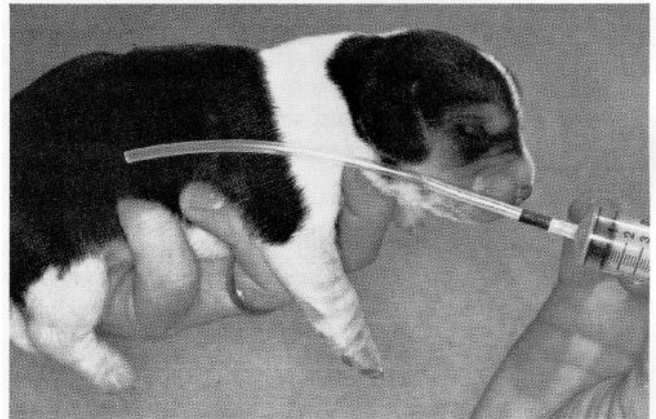

Three feedings, equally spaced during each day, are ample for puppies. Four daily feedings, equally spaced, can be used but are not necessary. Tube and hand-feeding can generally be terminated by the third week and certainly by the fourth. At this time all nourishment can be consumed by the puppy from his food dish.

The stimulation of the external anal and urinary orifices to effect defecation and urination is necessary when using hand-feeding. This cleaning should continue through the first two weeks. Cleaning can be done by gently massaging the orifices with cotton or a soft washcloth thereby stimulating elimination. If the mother is interested in the puppies, but doesn't have milk, then the feeding can be done by hand and she will clean them satisfactorily.

Internal Parasites

After you purchase a new pup or an older dog, you should take it and a small, fresh specimen of the bowel movement to your veterinarian. Ask your veterinarian the best time to bring the stool sample as worm cycles and worm age determine when the eggs will be visible. The bowel specimen need not be larger than the size of a marble which you may wrap in a piece of tinfoil or small plastic bag. If the mother of your puppy had a high infestation of the internal parasites, your puppy also may be infested. For this reason every bitch should be wormed before breeding. Your veterinarian, by microscopic examination, will be able to determine if any, and which type of, internal parasites are present. He will then be able to prescribe the amount and types of medication needed. Internal parasites commonly found in dogs are roundworms, hookworms, whipworms, tapeworms. Heartworms are also common in many areas and are detected by your veterinarian examining a blood sample.

The medication used for worming dogs acts by either killing the worms or causing them to go into a stupor, releasing their hold and thus being passed with the bowel movements. Because of its potential toxicity an overdose of worm medicine can be very harmful to the dog. Worming when unnecessary can be as harmful as not worming when needed. Consult your veterinarian for the proper medication to avoid unnecessary toxicity.

Roundworms

Roundworms, or ascarids, are the most common of the internal parasites. The eggs hatch in the intestines, enter the bloodstream as young embryos, migrate through all the body tissues and eventually migrate back to the intestines where they develop to maturity, lay eggs and thus start the cycle again. Adult roundworms may be passed in the stool, appearing as thin spaghetti about one to three inches long.

Symptoms of infestation in puppies are poor growth rate, potbelly, diarrhea and excessive eating. Puppies may be born with roundworms if the mother is infected.



Figure 28 -Poor health can be caused by improper feeding, internal parasites and other disorders. Have your dog's health checked annually by your veterinarian.

Hookworms

Hookworms are commonly found in puppies, but older dogs may also be heavily infected. Hookworms also may be passed on to puppies from their mothers. They are small, white and hair-like in shape. Symptoms are similar to that of roundworms except blood may appear in the diarrhea-like stools. Hookworms suck blood from the intestinal wall, and the loss of blood may cause the dog to be anemic. Blood transfusions may be necessary to build the dog up before worming. In a young puppy especially, hookworms can be life threatening.

Whipworms

Whipworms inhabit the large intestine and cecum. They are white in color and measure from 50 to 75 mm in length. Symptoms include rough hair coat, poor condition, abdominal discomfort and diarrhea.

Tapeworms

Tapeworms, when present, are usually found in mature dogs. There are two species of tapeworms, *Dipylidium* and *Taenia*. The *Dipylidium* spends a part of its life cycle in the flea and the *Taenia* spends a part of its cycle in the rabbit or mouse. The dog must ingest either an infected flea or rabbit or mouse to become infected. Control of fleas and rodents is an essential part of tapeworm control in the dog.

The tapeworm attaches itself to the lining of the small intestine. The body and tail of the long, flat parasite flow free. Segments of the parasite may break off and are passed in the stool appearing as white mobile worms. Tapeworm segments may stick to the hair around the rectum. They also may appear as dry, straw colored, rice grains in the dog's bed.

Heartworms

Heartworms are internal parasites of the heart. The adult heartworms occupy the chambers of the heart and larger blood vessels. Heartworms are spread from dog to dog by mosquitoes. The female heartworms release living larvae (*microfilariae*) directly into the dog's bloodstream. These larvae are then removed from the infected dog's bloodstream by the mosquito. After a short period of development (10-14 days) in the mosquito, the larvae are transmitted to another dog when the mosquito takes another blood meal. After the larvae enter the dog's system, they develop further and eventually reach the heart as mature worms. This developmental period takes about six months. The mature male and female heartworms then produce microfilariae which then can be detected in the dog's blood by microscopic examination.

The presence of heartworm disease has been more common in the south and southeastern part of the United States. However, the disease has been identified in the northeast, midwest and western states.

The first symptoms of heartworm infection are: shortness of breath, a shallow cough and a tendency toward easy tiring. These symptoms are seldom observed when microfilariae are first detectable in the dog's bloodstream, but appear after the adult worms have infested the heart and adjacent blood vessels. Early diagnosis is therefore important, and if you live in a state where heartworm infection is common, you should discuss this disease with your veterinarian and have a plan for early diagnosis and treatment. Preventive drugs are usually prescribed during the mosquito season.

Dog Diseases Which May Be Transmitted to Humans

The danger of contracting a disease from your dog is not very likely if you use common sense in sanitation. The chances of contracting a contagious disease from another human is much greater than from a dog, because most diseases are rather specific for the host, whether it be animal or man. If this were not true, we would indeed be more concerned about the health of the approximately 45 million dogs in the United States.

Roundworm Infection

Some diseases, however, may be transmitted from dogs to humans, roundworm infection being one. Many dogs in the United States are infested to some extent with the parasite *Toxocara canis*, commonly known as roundworm or ascarid.

In cases of human infection, roundworm is usually found in children one- to three-years-old who play on soil contaminated with roundworm eggs. Eggs deposited in dog feces

may remain in the soil for long periods of time. Children may easily introduce the eggs into their mouth. Small children also may contract eggs from puppies that have not been housebroken. Puppies and dogs should be trained not to lick one's face as eggs may be transmitted in this manner. Dog pens and the run area where a dog is tied may be infested and should be off limits to young children. Symptoms of infestation in children are similar to the dog. Occasionally, migrating larvae may cause an enlarged liver and invade the central nervous system or the eye.

Skin Diseases

Skin diseases of dogs such as ringworm and mange may be transmitted to humans by contact. Young children are more susceptible, but adults also may develop lesions. Therefore, dogs with skin lesions should be handled with minimum contact and treated by a veterinarian at once. Washing thoroughly with soap and water after handling the dog reduces the risk of infection.

Bacterial Infection

There are a variety of bacterial infections which can be transmitted by a dog bite. Each year an estimated 600,000 people are bitten and treated. It has been estimated that two or three times as many bites go untreated. A very common wound infection from dog bites is caused by *Pasteurella multocida* which can produce a very severe local wound infection. Dog bite victims should be treated at once by the family physician.

Dogs also may transmit *Pasteurella tularensis* organisms which cause "rabbit fever." A dog that has eaten an infected rabbit or rodent will have infected saliva and mouth parts. In this circumstance, although rare, the infection could be transmitted from a bite or lick. Symptoms in humans are high fever, headache, recurring chills, nausea, vomiting, swollen lymph nodes, severe prostration, extreme weakness and drenching sweats. Symptoms in the dog are similar to man.

Leptospirosis

Symptoms of leptospirosis in humans are fever, headache, muscular aches, inflammation of the eyelids and occasionally jaundice. Dogs exhibit similar signs. The organism is shed in the urine. Dogs contract it by sniffing air droplets from bushes that have recently been urinated on by an infected dog. An occupational hazard exists among veterinarians and kennel helpers who frequently come in contact with dog urine. The occasional dog owner who is careless about sanitation also may become infected. Public beaches exposed to dogs also serve as a source of contamination. The usual culprit however is the rat.

Dogs may be vaccinated for protection. Dogs that travel widely to shows and field trials should have a booster shot for added protection because the disease can occur in immunized dogs if sufficiently exposed to a virulent organism. The organism can be readily inactivated by spraying with a disinfectant; kennels and dog equipment can be easily disinfected. The ordinary pet owner is advised to avoid urine and urine contaminated areas as much as possible and use a disinfectant spray when needed.

Rocky Mountain Spotted Fever

The tick serves as the host for Rocky Mountain Spotted Fever. A dog may serve as the host for an infected tick, thus bringing the disease to man. Care should be taken to avoid contamination when removing ticks from dogs because the crushed tissues or feces of ticks can be virulent. Avoid leaving the head or mouth parts in the skin. Cotton moistened with rubbing alcohol and a tweezer may be useful in removing them.

In humans, symptoms of this disease are high fever, chills, weakness and nausea. Lesions may appear at the point of infection. Symptoms of infection in dogs are not apparent, with diagnosis made by blood testing.

Rabies

Although much is known about rabies, it still remains a public health problem. In spite of the free vaccination programs in many cities and towns, between 200 and 300 cases occur in dogs each year in the United States.

Because of the great dangers of this disease to humans, all dog owners have an obligation to vaccinate their puppies according to state laws and at regular intervals as necessary. It is required in most states. Even though no case of rabies has been reported in your area, perhaps for years, your dog should be vaccinated.

Common Sense Sanitation

Nearly all diseases of dogs are spread by direct contact with an infected animal or its wastes. Cleaning the lawn and kennel area of dog droppings and supervising small children that spend much of their time crawling is a necessity. Dogs and puppies should be trained not to lick the faces and hands of people. The dog cleans its genital parts and rectum by licking and therefore can spread infective organisms. Dogs and puppies can be easily trained by giving a quick slap and saying "No" as the mistake is made.

The owners of one or two dogs need have no fear of dog diseases if they follow common sense sanitation practices



Figure 29 -Patio blocks can be used to form a clean, dry, attractive area around a dog house from which droppings can be easily cleaned. A home owner can place them without previous experience.

and avoid direct contact with infected animals or animal wastes.

External Parasites

Most dogs, at some time or another, will acquire external parasites. Clean quarters and premises are important to the control of external parasites; however, they may be transferred readily from contact with other dogs.

The Flea

The flea is a blood-sucking parasite that may cause anemia, transmit tapeworm and other diseases, contribute to skin diseases and cause great irritation. The small black specks found in the dog's hair are fecal droppings of the fleas. Flea eggs are minute in size and white in color.

Flea powders, soaps and shampoos are effective in killing the fleas they come in contact with, but new eggs may hatch eight to 10 days later, and the flea population will soon be as high as before. The flea's eggs may be laid in bedding, grass, the dog's favorite chair or any place the dog spends much of his time. To effectively control fleas, their life cycle must be broken by the repeated use of insecticide medication on the dog, as well as the areas where the fleas' eggs may have been laid. The treatment should be made at weekly intervals for two or three weeks to effectively reduce the population. A vacuum cleaner will be useful to remove eggs that may have been laid on the living room rug.

Lice

Lice are small blue-black parasites that bury their mouth parts in the skin of the dog and then suck blood. The irritation causes scratching which may lead to skin problems. A high infestation of lice may cause anemia due to the extensive blood sucking. Lice lay their eggs in the dog's coat by attaching them firmly to the hair. The lice eggs are called nits and are light colored, waxy bodies.

Medicated soaps, powders and shampoos are effective in controlling lice; however, the treatment must be repeated at weekly intervals for two or three weeks in order to break the life cycle.

Ticks

Dogs may acquire ticks by running through wooded areas and shrubbery. They attach themselves primarily about the head, neck, ears and toes. Ticks vary in size and shape by specie. They may be brownish or red in color and flat in shape, and no longer than 1/4 inch, or when engorged with blood, may appear as large as coffee beans and gray in color. They are more prevalent in summer and in warm climates and can usually be controlled by close examination of your dog's coat. Rubbing alcohol dabbed on the tick with cotton usually will cause it to release its hold so that you can remove it without breaking off the mouth parts attached to the dog's skin. A tweezers also will be helpful to you in removing the mouth parts should they break off. It is very important to remove the mouth parts to avoid an abscessed or ulcerated area. The area that has been bitten by the tick usually will heal rapidly with little attention after the tick has been removed properly.

Sarcoptic Mange

Sarcoptic mange is caused by a mite which burrows into the skin causing severe itching and thickening of the skin. A "mouse odor" given off by the skin also may be noticeable. A positive diagnosis may be made by microscopic examination of skin scrapings.

The disease can spread rapidly from dog to dog and also may be transmitted to humans. Early diagnosis and treatment are necessary to prevent the spread of the disease and for self protection. The risk of infection will be reduced by washing thoroughly with soap and water after handling the dog.

Ringworm

Ringworm may be caused by at least three fungi, *Microsporum canis* being the most common. The disease is characterized by circular, scaly areas where the hair has been lost. Pustules may have formed, and there may be redness of the skin. Positive identification may be made by

ultra violet examination of skin scrapings.

The disease may be readily transmitted among dogs and to humans. You should seek veterinary advice as soon as signs of ringworm appear. Excellent control methods have been developed. Thorough washing with soap and water after handling the dog will reduce the risk of infection to humans.

Diseases Preventable by Vaccination

Distemper, hepatitis, leptospirosis, parvovirus, some respiratory diseases, and rabies may be prevented by vaccination. Most veterinarians suggest vaccinations for distemper, hepatitis and leptospirosis at six to eight weeks of age with booster shots at intervals thereafter. Veterinarians recommend annual booster shots for older dogs also. Most veterinarians will recommend rabies vaccinations at three to four months of age, with annual booster shots. The vaccination recommendations are rather general in nature and may vary from state to state and veterinarian to veterinarian. It is most important, however, that you understand the importance of a vaccination program for these diseases and follow the recommendations of your veterinarian.

Distemper

Distemper is one of the most widely known diseases of dogs. It is contagious and causes a large number of deaths. It is a febrile virus disease with symptoms of runny eyes and nose, the discharge being clear to yellow. Vomiting and diarrhea occur. A low, hacking cough also may be present. The dog often will show loss of appetite and depression. The symptoms progress to nervous signs including a twitching of the muscles and mild to severe paralysis or convulsions. After the nervous signs appear, there is little hope for the dog.

Hepatitis

Hepatitis is a virus disease with symptoms of profuse vomiting, increased thirst and extreme depression. The disease causes rapid death in young dogs; however, older dogs that recover from the initial illness are faced with long convalescence. A bluish-tinge to the eyes may result that will disappear very slowly. The symptoms are caused by the virus affecting the liver. The dog virus cannot cause Hepatitis in people.

Leptospirosis

Leptospirosis is a bacterial disease. The onset of the disease may be very sudden with symptoms of fever, refusal of food, weakness, vomiting and an increased thirst. It is expensive to treat and usually fatal or very debilitating to an afflicted dog.

Rabies

Rabies is a virus disease that can affect all warm-blooded animals. The affected animal salivates profusely because he cannot swallow. The virus is released from the salivary glands and may be transmitted to others by biting or through an open wound. Affected animals may behave in an erratic manner. They may appear very dull or very wild, frantic or furious. The disease is always fatal, so preventive vaccination is a must. If a person is bitten by a rabid animal, treatment must be initiated immediately.

First Aid for Your Dog

Early recognition of illness or injury is important in keeping your dog healthy. You may learn to diagnose and treat simple ailments and injuries, but it is generally best to rely upon your veterinarian for care of serious injury.

The first sign of illness or injury is a change of mood. Your dog may become irritable, sluggish and show a lack of appetite. His eyes may become red and inflamed. There may be a nasal discharge. Other symptoms include trembling, coughing, fever, (temperature over 102.5°F), persistent vomiting, diarrhea or a change in the color or consistency of the stool.

Bee stings-One or two bee stings usually cause very little discomfort for a dog. If the dog is biting at a bee sting, apply a paste of bicarbonate of soda and water. If the dog has been badly stung he will need the immediate attention of a veterinarian. Severe allergic reactions may occur occasionally, just as in humans.

Choking-The dog may gag, try to vomit or drool. Check for a bone or foreign object caught in the throat or mouth. If the dog has recently been bitten by another dog or a wild animal, rush him to a veterinarian. Choking can be one of the first signs of rabies.

Minor cuts and scratches-Wash the wound with soap and water. Keep it clean. Watch for signs of infection, such as redness, pain, swelling, and drainage of pus.

Diarrhea-This may be caused by a change of diet, milk, too much grease from the kitchen added to the dog's food or perhaps overeating. Give the dog one teaspoon to one tablespoon Kaopectate® two or three times a day depending on the size of the dog. If diarrhea continues beyond 24 hours or is severe, see your veterinarian at once.

Eating grass-Most dogs like to eat some grass. The long, coarse pieces seem to be preferred. After eating grass a dog may vomit; this will do no harm. The reasons for this behavior are not really known.

Electric shock-If the electric cord is still in the dog's mouth or touching the dog, pull out the plug before



Figure 30 —An injured dog may panic and bite. A simple muzzle is the easiest restraint. A piece of cloth, bandage or rope about two feet long will serve well by wrapping it twice around the muzzle, crossing under the throat and tying behind the ears.

touching the dog (to avoid a shock to yourself). If the dog has had a severe shock and is in a partial coma, give him artificial respiration by applying rhythmic pressure to the chest. Telephone your veterinarian for immediate instructions.

Eye infection or injury-With the aid of an eye washing glass, wash the eye with a lukewarm boric acid solution. Apply a few drops of a medicated eyedrop solution, available at most drug stores, for the temporary relief of burning eyes. Call your veterinarian immediately.

Seizures (convulsions)-This is characterized by running wild, then backing up and falling over, convulsions, foaming at the mouth, glassy eyes or a moaning howl. The seizure may last only two or three minutes. Do not touch the animal as you may be accidentally bitten. After the seizure passes, place the dog in a dark, quiet area.

Convulsions may result from poisoning, high fever, or epilepsy, and may be associated with many diseases. Their cause is frequently hard to determine. Call your veterinarian immediately.

Heatstroke-A dog tied with no protection from the sun, or locked in a car is vulnerable to heatstroke. He may pant excessively or collapse. The most effective treatment is probably immersing the dog in cold water. If this isn't possible, spray him with cold water from a garden hose. Ice packs on the head and neck may also be applied. The animal should be taken to a veterinarian as soon as possible.

Hit by a car-The dog may be suffering from multiple fractures, internal injuries or shock. Muzzle the dog

immediately to avoid being bitten. Slide a board under the dog to serve as a stretcher and rush him to the veterinarian. Place a blanket over the dog to keep him warm and keep him as quiet as possible.

Motion sickness-The dog will drool, become nauseated and vomit. Short trips in a car as a puppy usually will help overcome this problem. A dog or puppy which suffers from motion sickness should not be fed three to four hours before starting a trip in a car. Your veterinarian can prescribe medication for motion sickness.

Poison-The dog may show signs of poisoning by cries, crouching, vomiting, diarrhea, trembling, hard breathing, convulsions or a coma. If you can determine the kind of poison taken, treat with the suggested antidote on the container. A general antidote is milk or slightly beaten egg white. Vinegar is an antidote for alkali poisons; bicarbonate of soda for acid poisons; Epsom salts for lead poisons; peroxide for phosphorus in some rat poisons. To make a dog vomit, place several tablespoons of salt on the back of the dog's tongue. Hold his mouth closed until he swallows. Rush your dog to the veterinarian even though he may appear to have recovered.

Porcupine quills-The quills usually will be in the nose and face of the dog. Therefore, use a narrow leather strap or nylon cord to muzzle the dog. Hold firmly and pull the quills with pliers. Remove the quills from the mouth and around the eyes first. In severe cases you will need the services of a veterinarian who may have to use an anesthetic.

Skunk odor-Wash eyes with warm boric acid solution, then bathe the dog completely with tomato juice or soup. Allow the tomato juice to remain in the coat for about 20 minutes. Then wash with pine-scented or chlorophyll soap or one of the commercial dog shampoos.

Snake bites-The dog may show a swollen area, pain, weakness, difficulty in breathing and prostration. Muzzle the dog, hold firmly and make an X-shaped cut over the fang marks with a razor blade. Use a suction bulb to draw out the poison. Place a tourniquet between the body and the wound. Rush the dog to a veterinarian for antivenin shots.

Building a Suitable Dog House

A dog that lives outdoors should have a house that includes these basic requirements. It should be warm in winter, cool in summer, draft free, dry at all times, easy to clean, have a sun deck, provide shade and encourage exercise.

The plans for this house insure warmth in winter as there is an inner compartment or "bedroom". The "bedroom" is of

such a size that the dog can warm it with its body heat. The inner compartment door is toward the back of the house and prevents drafts. The "living room" or area just inside the door provides a vantage point from which a dog enjoys keeping surveillance over his "property". A dog likes to lie in this area during the day with just his nose outside the door in order to scent friends or foes that might be paying a visit. A three- to four-inch layer of straw makes a good bedding for both areas of the house. A blanket or rug is not suitable as it tends to wad up, absorbs moisture and offers no warmth.

This house is cool in summer, as the partition can be taken out, doubling the sleeping area. It stays dry at all times because it is off the ground allowing complete air circulation. It is easy to clean as the side flap can be raised and the roof lifted off allowing for sweeping and spraying for external parasites. The roof has a low pitch and thus encourages a dog to sun himself. Dogs especially make use of this during late winter and spring. The roof overhang in front helps keep out the rain. The height of the roof is such that the dog will get good exercise from jumping on to it. Use wood preservative on the legs. Place the legs on bricks set partially in the ground so moisture is not readily absorbed.

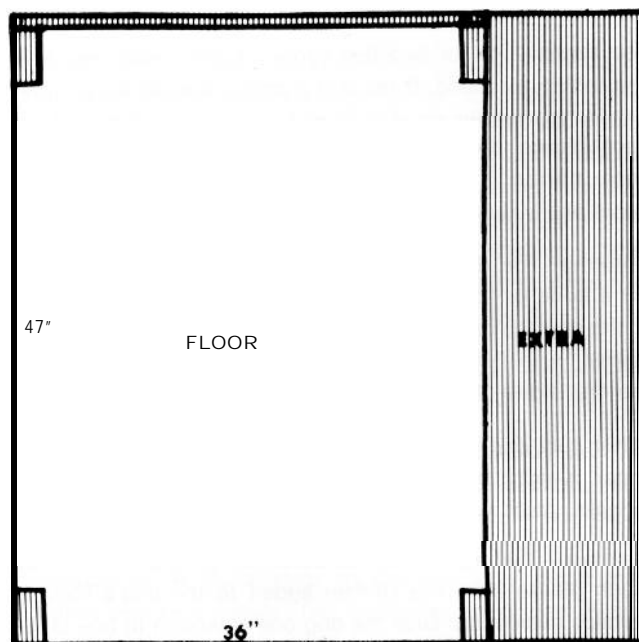

One-half sheet (4' x 4') 3/4" plywood

This house is for a medium-sized dog, 40-75 pounds. It should be cut down for smaller dogs. The floor can then be made from one-half-inch plywood. Most houses are made too large for the dog and it is then not able to warm the house with its own body heat. For a dog no larger than a beagle, the floor space need not be larger than 2 x 2 feet and the peak of the roof only 18 inches. The "bedroom" is then only about 1 x 2 feet.

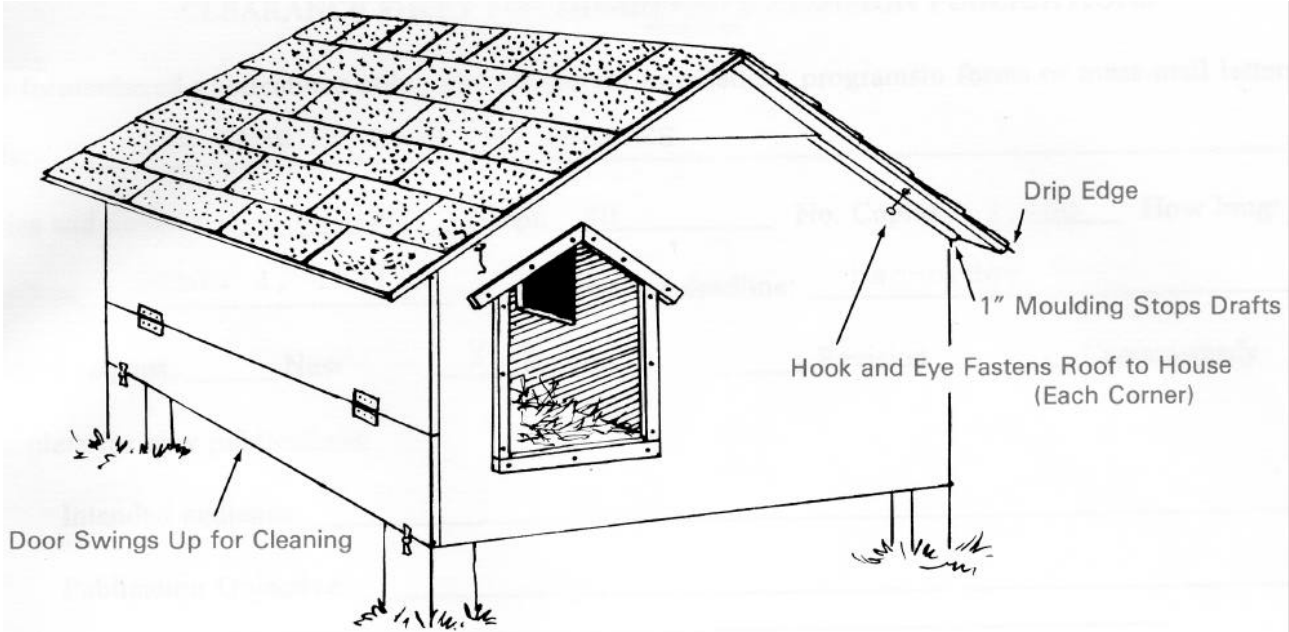

Materials needed:

- Two sheets 4' x 8' exterior plywood, 1/2" thickness
- One-half sheet (4' x 4') exterior plywood, 3/4" thickness
- Four 2" x 4"s, 25" long (legs for house)
- Four 2" x 4"s, 16" long (braces to tie roof pieces together)
- Six feet of 1" x 2" stock
- Ten feet of 1" quarter round molding
- Drip edge, 8'
- Two 2" hinges
- Two 2" turn buttons
- Four 2" screen door hooks and eyes
- Two lbs. #10 coated nails

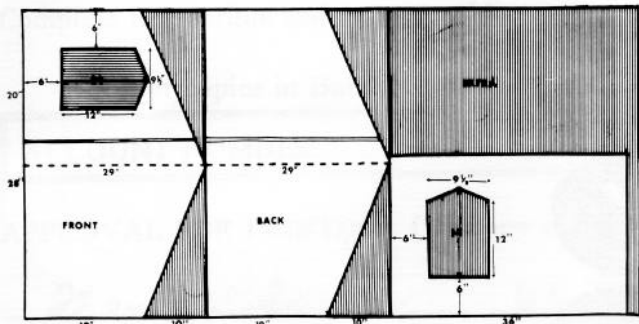

One sheet 4' x 8' x 1/2" plywood

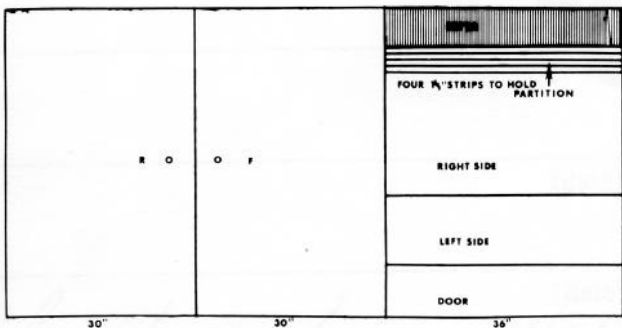

One sheet 4' x 8' x 1/2" plywood

